



41728





Get excited about our new packaging!

We're switching from plastic to paper-based packaging. That's why you might find a mix of paper and plastic in our boxes!

Nos nouveaux emballages vous emballeront !

Nous passons des emballages en plastique aux emballages à base de papier. C'est pourquoi vous pourriez trouver un mélange de papier et de plastique dans nos boîtes !

¡Te presentamos nuestros nuevos empaques!

Estamos sustituyendo las bolsas de plástico por bolsas con base de papel. ¡Por eso, puedes encontrar una mezcla de papel y de plástico en nuestras cajas!

[LEGO.com/sustainable-packaging](https://www.lego.com/sustainable-packaging)



BUILDER



Apple and the Apple logo are trademarks of Apple Inc., registered in the U.S. and other countries and regions. App Store is a service mark of Apple Inc. Google Play and the Google Play logo are trademarks of Google LLC. Tencent and the Tencent logo are trademarks of Tencent Inc.

[LEGO.com/devicecheck](https://www.lego.com/devicecheck)

EN Ask parents' permission before going online | **DE** Eltern um Erlaubnis bitten, bevor du online gehst | **FR** Demande l'autorisation d'un parent avant d'aller en ligne | **IT** Chiedi il permesso ai tuoi genitori prima di andare online | **ES** Pídeles permiso a tus papás antes de conectarte a Internet | **PT** Peça autorização aos pais antes de acederes online | **JA** オンラインになる前に ほかの方のきよかもをもらおう | **ZH** 上网前应先征得父母的同意 | **KO** 온라인 접속 전에 보호자 동의가 필요합니다 | **RU** Спроси разрешения у родителей, прежде чем заходить в интернет | **PL** Poproś rodziców o zgodę, zanim wejdiesz do Internetu | **CS** Než půjdeš na internet, požádej rodiče o svolení | **SK** Skôr než pôjdeš na internet, vypýtaj si povolenie od rodičov | **HU** Kérj szülői engedélyt, mielőtt online csatlakoznál! | **RO** Cere permisiunea părinților înainte de a te conecta online | **BG** Поискайте разрешение от родител, преди да влезете онлайн | **LV** Pirms došanās tiešsaistē palūdz atļauju vecākiem | **ET** Enne Interneti kasutamist küsi vanematelt luba | **LT** Prieš prisijungdami prie interneto, atsiklauskite tėvų



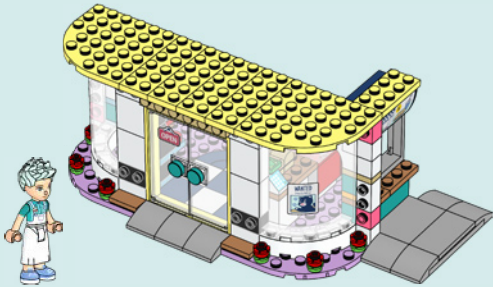



LIANN

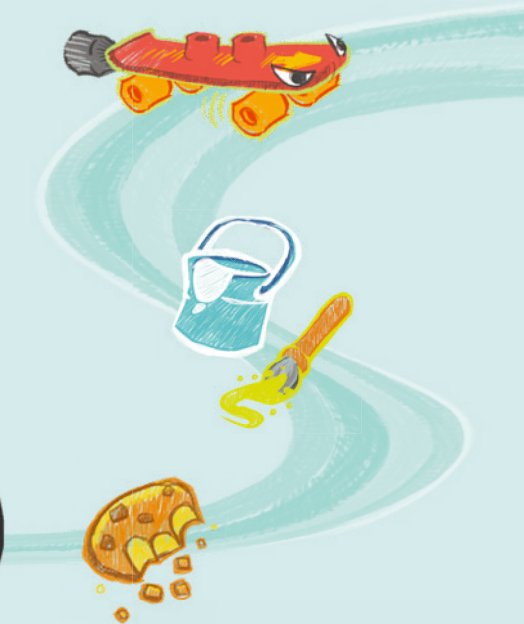
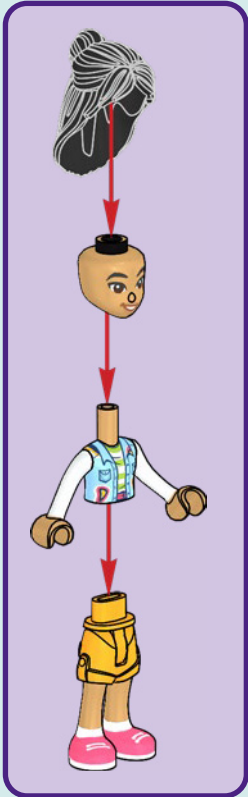

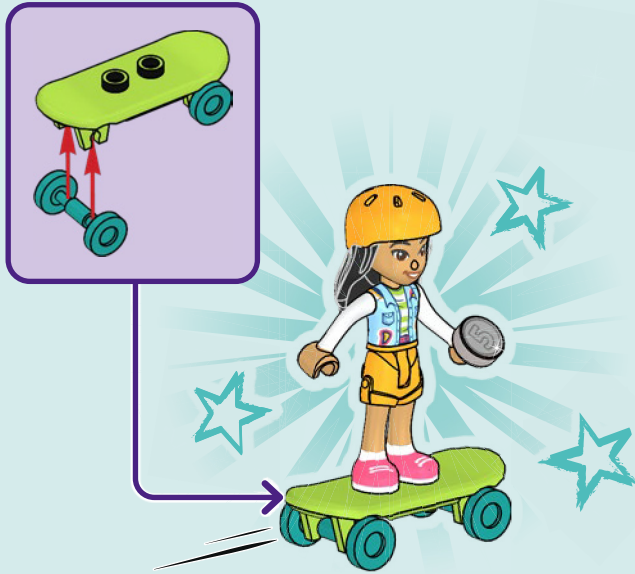
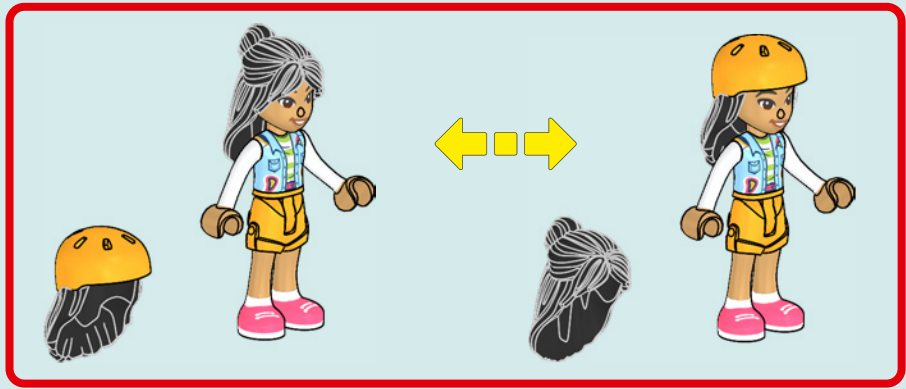

ALIYA

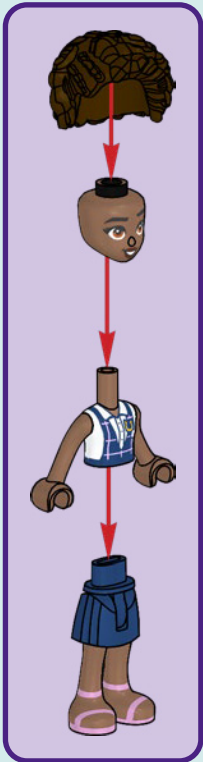



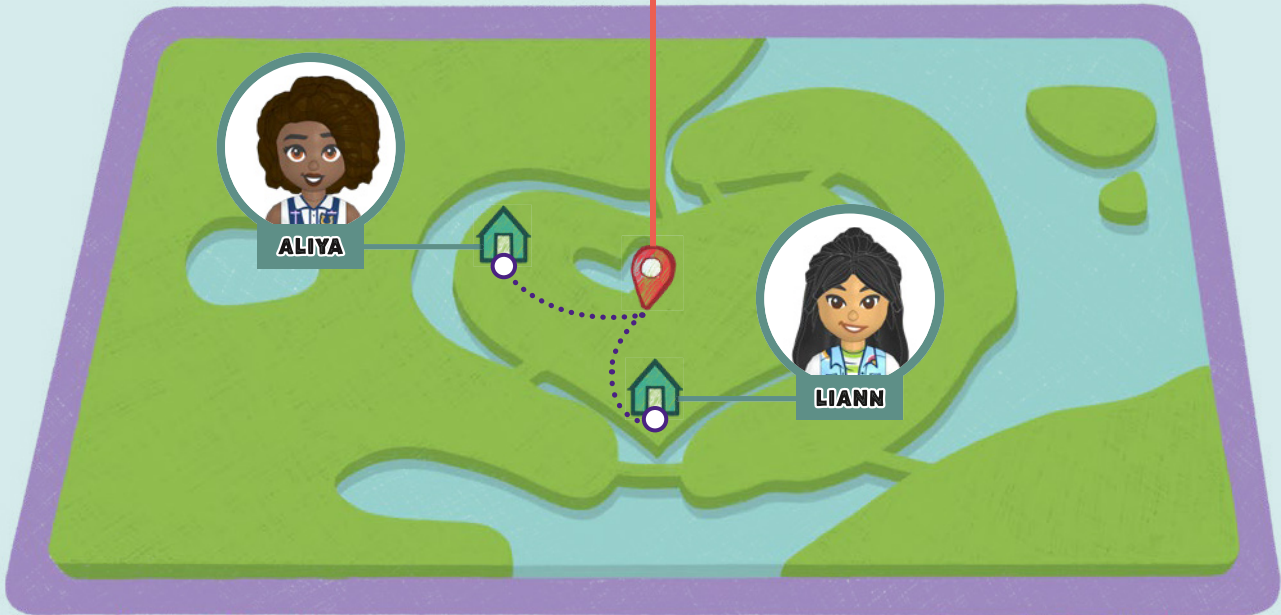

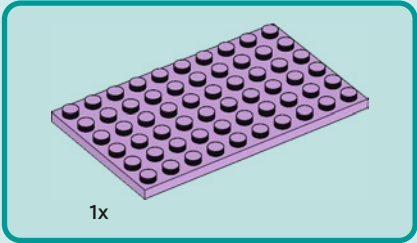
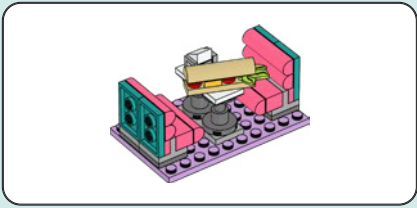

1x

1

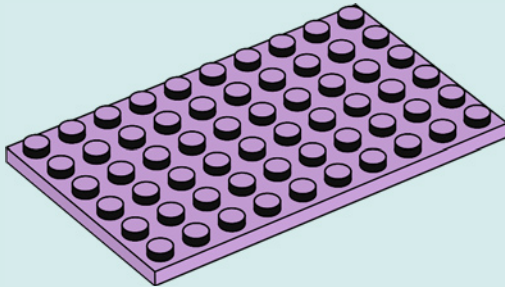

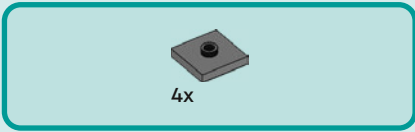

2

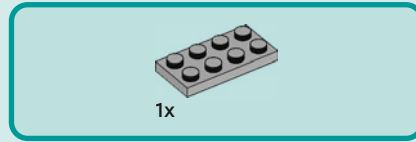
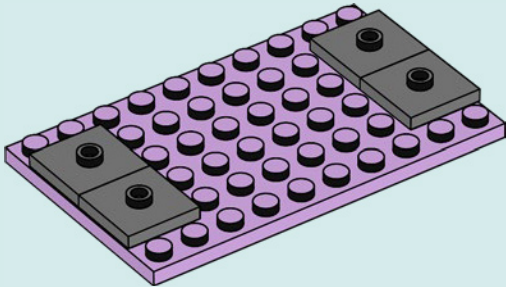

3

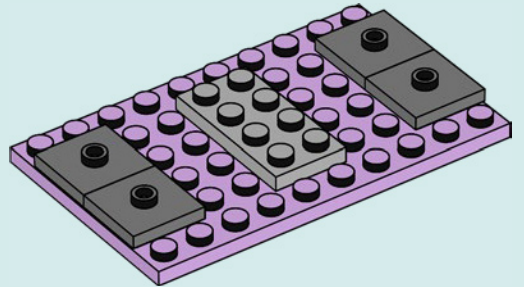



2x

4

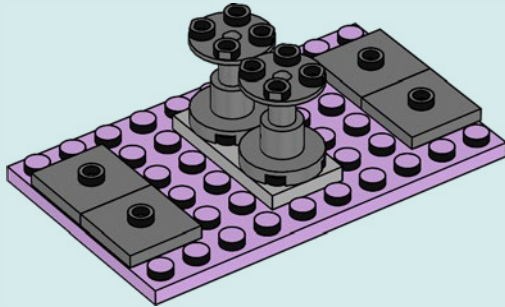

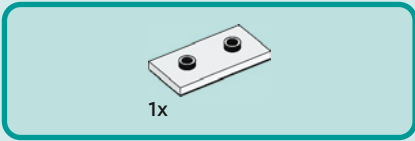

5

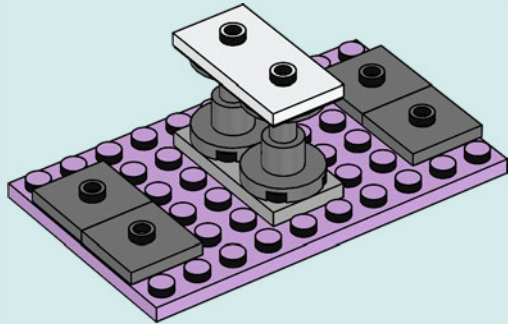



2x

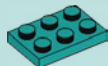

1x



1x

6

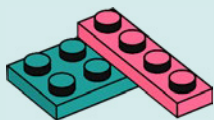

1x

7

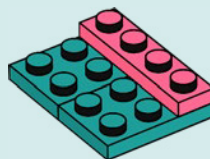

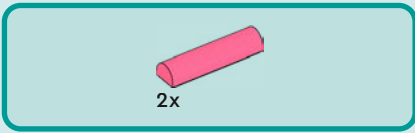

8

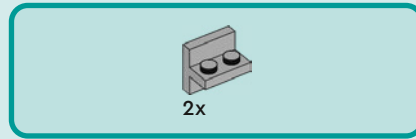
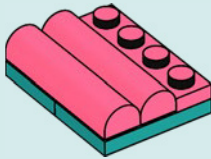

9

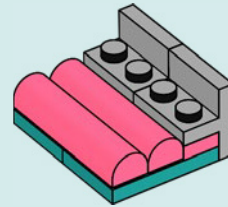



2x

10

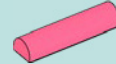
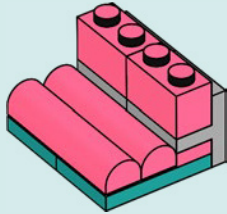

1x

11

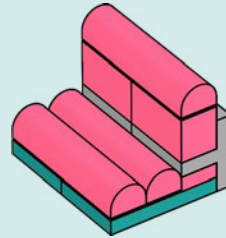

12

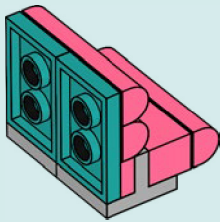

2x

13

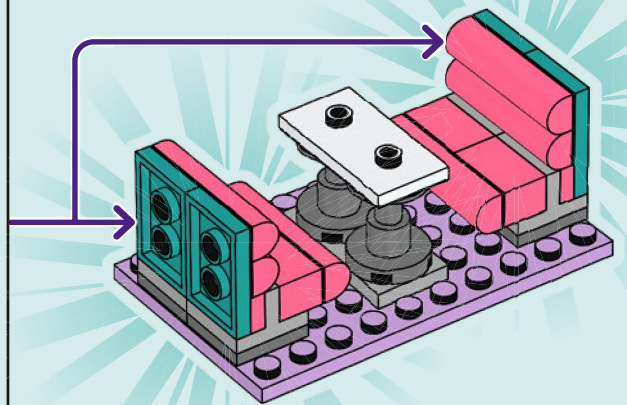

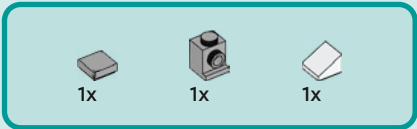

14

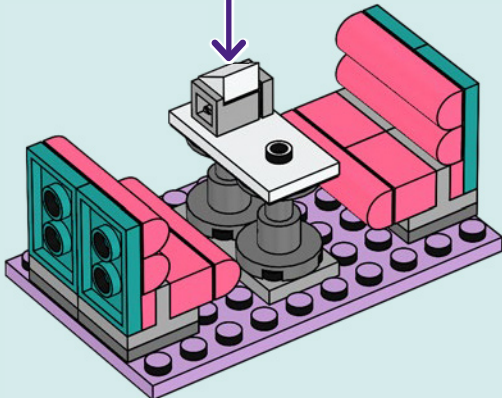
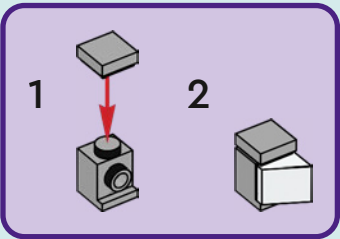

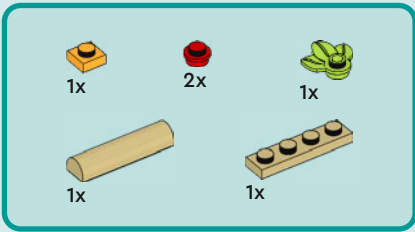

15

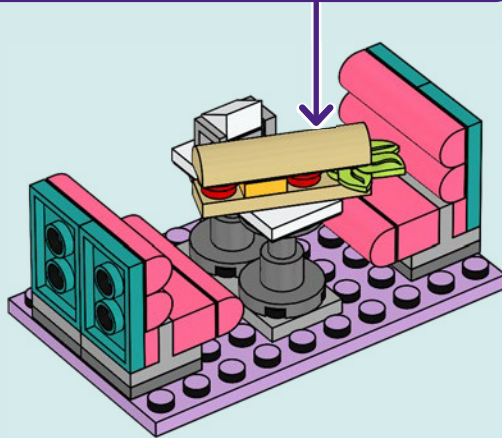
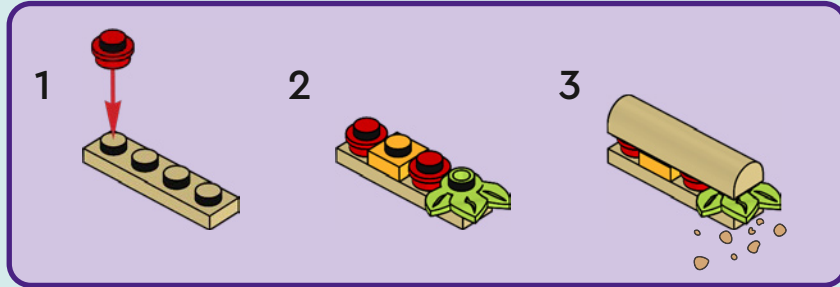

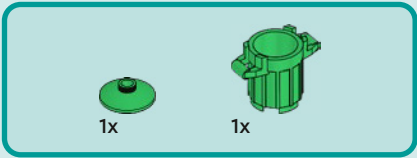

16

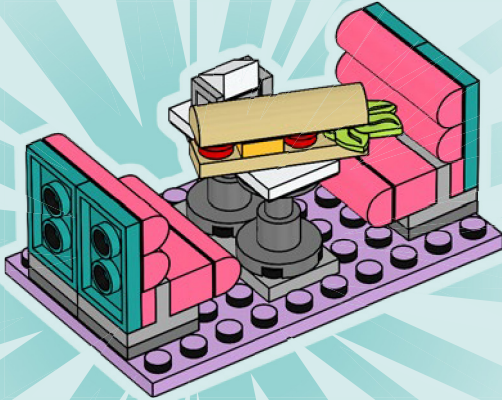
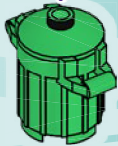
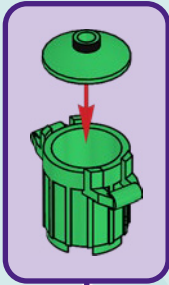



1

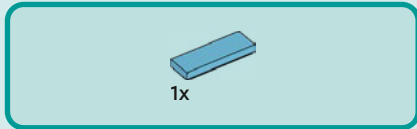
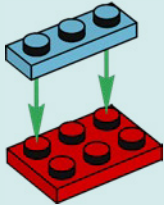

2

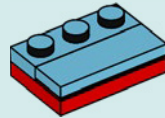



4x

3



2x



1x

4

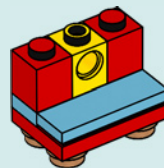

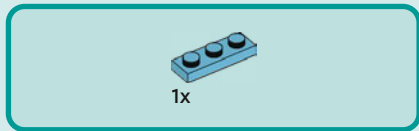

5

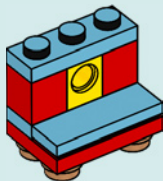

6

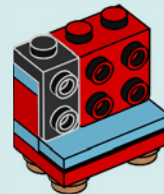



1x



2x

7

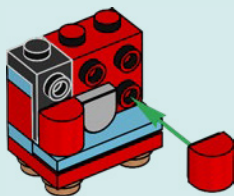

1x



2x

8

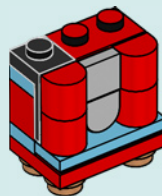

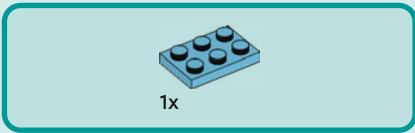

9

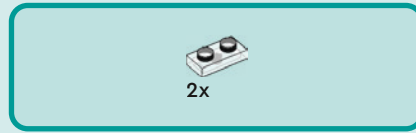
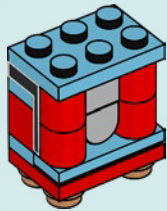

10

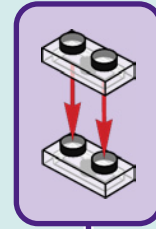



1x



2x

11



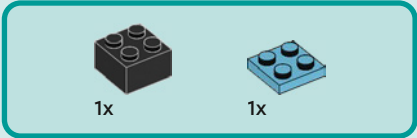

1

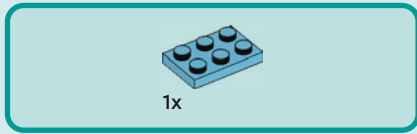
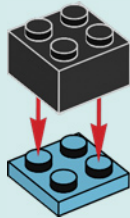

2

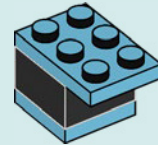



1x

3

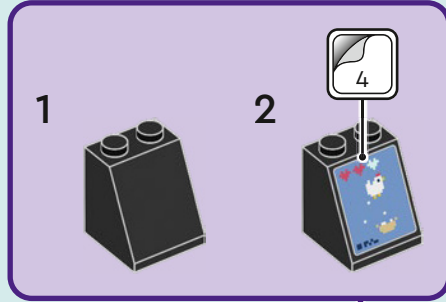



4

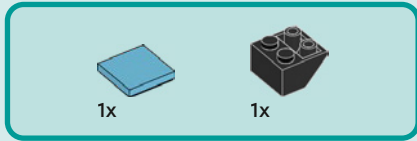

5

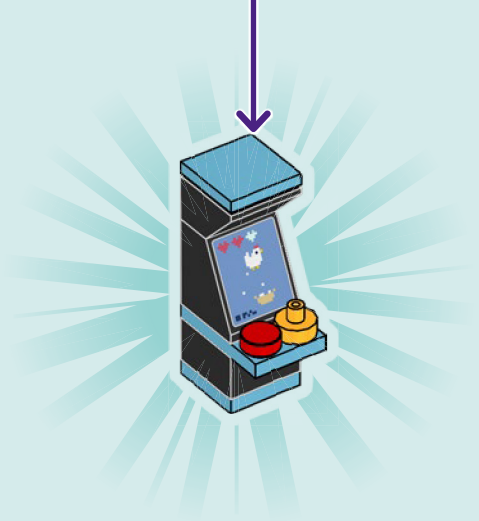
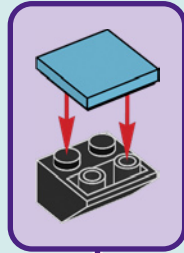

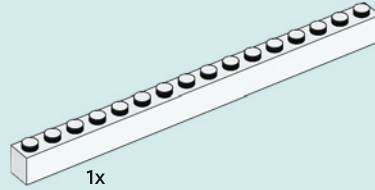
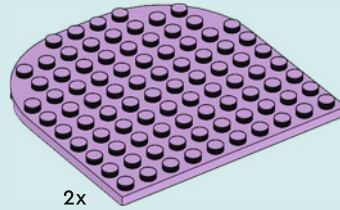
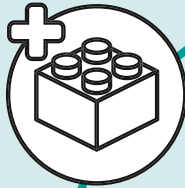

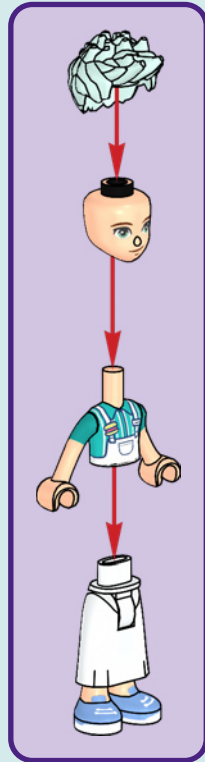

CHARLI



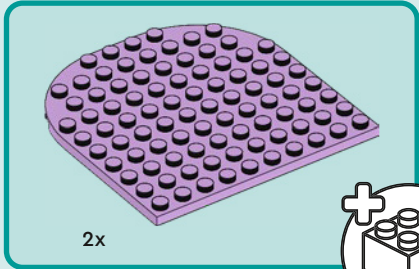
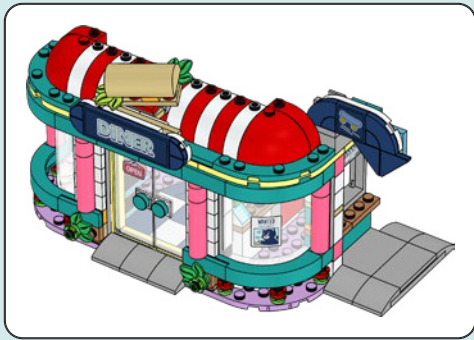

2x

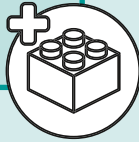

1

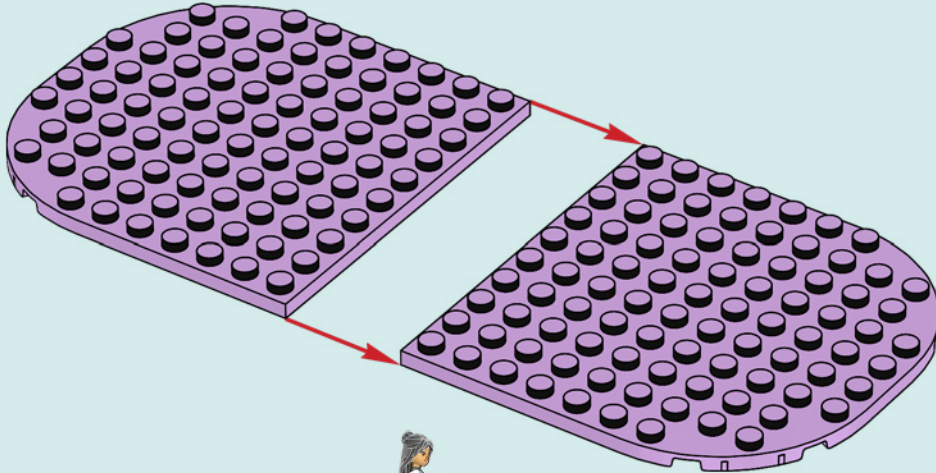



1x

2

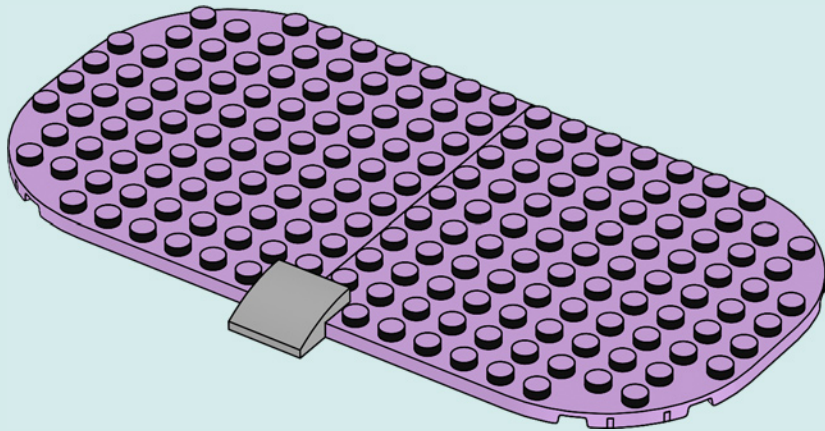



2x

3

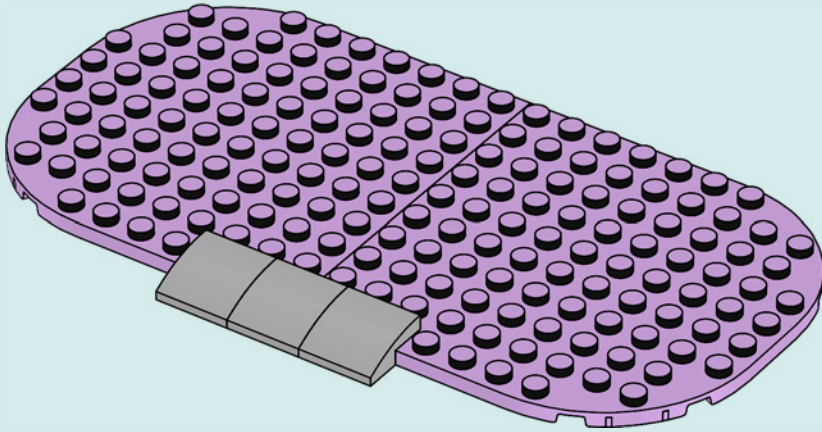

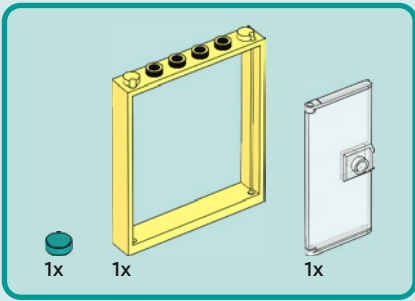

4

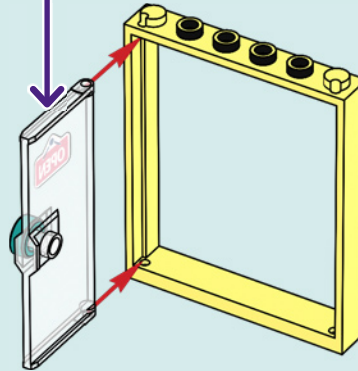
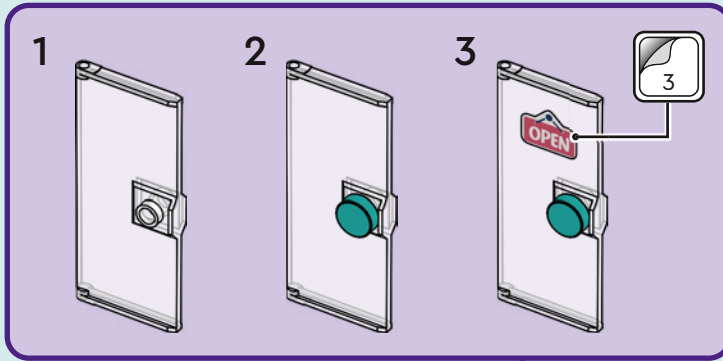

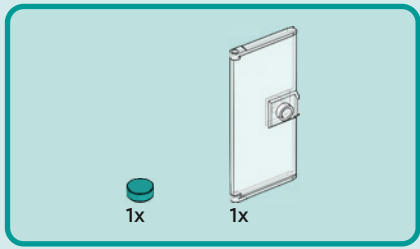

5

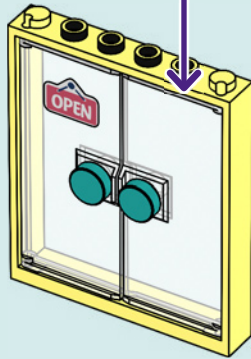
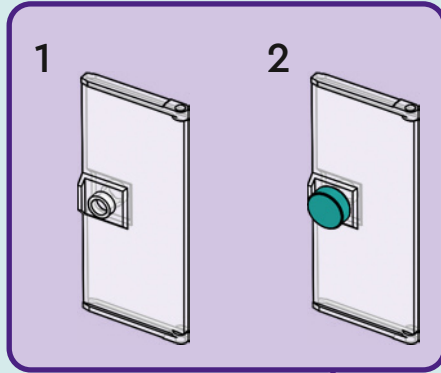

6

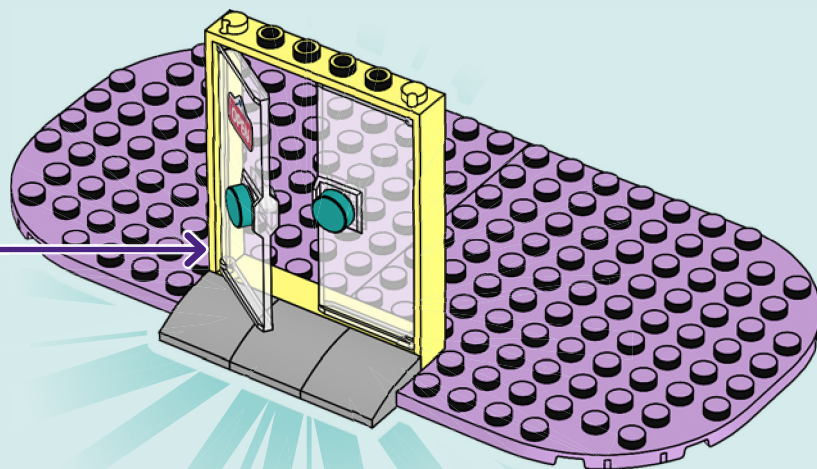



2x



2x

7

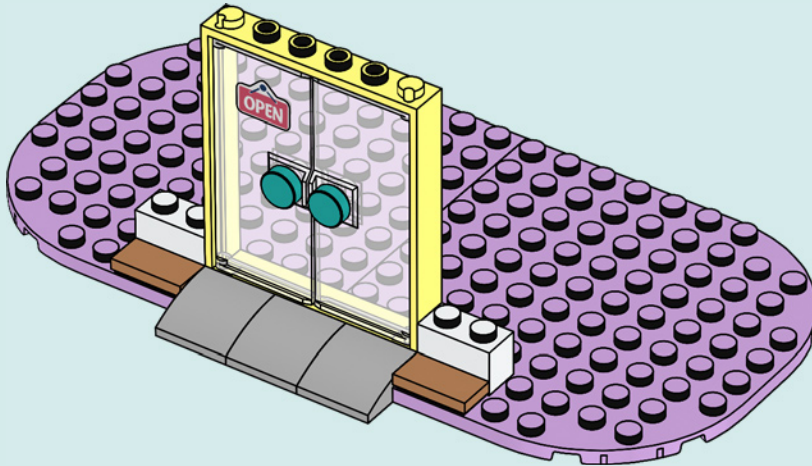

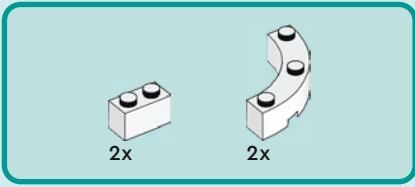

8

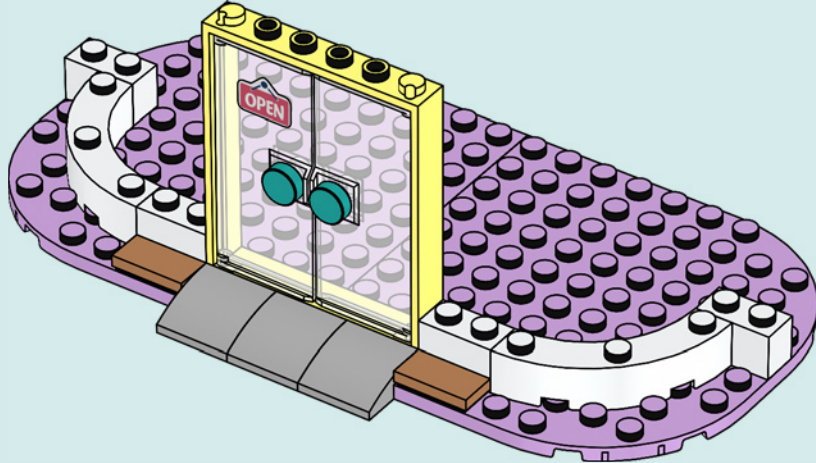



6x



6x

9

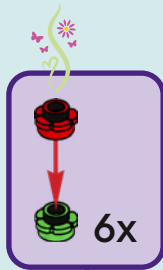



2x



2x

10

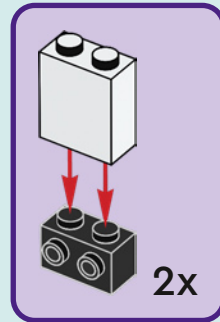



1x

11

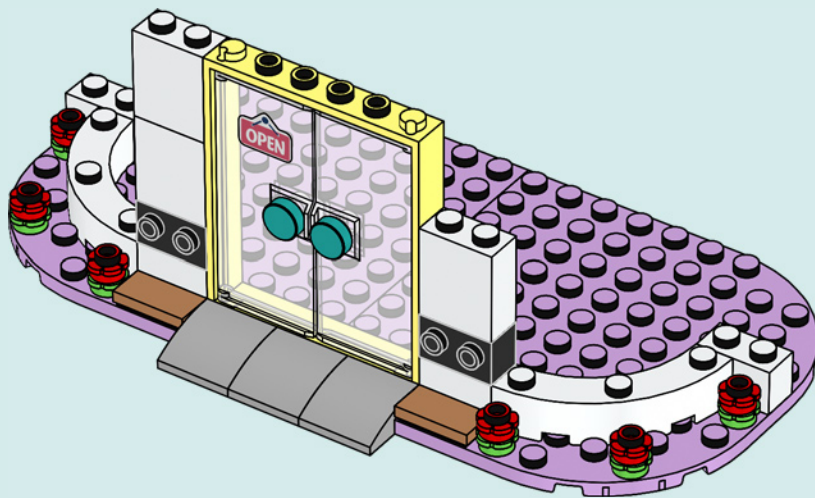

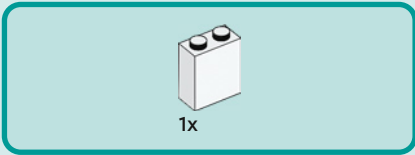

12

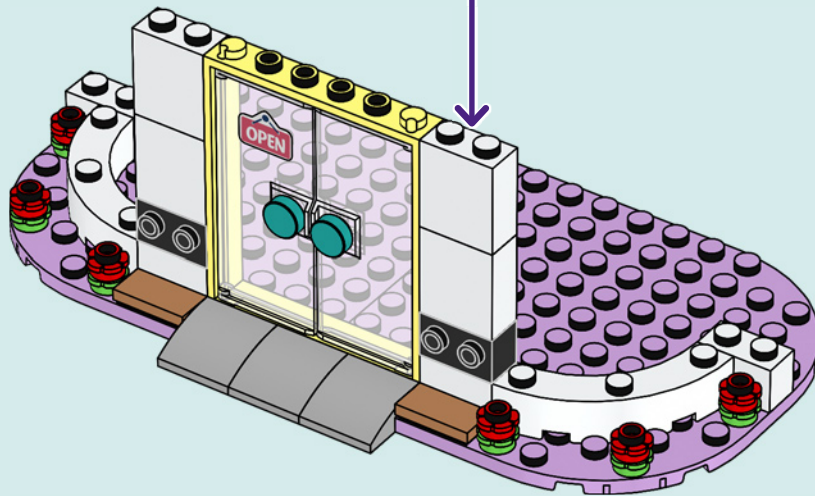
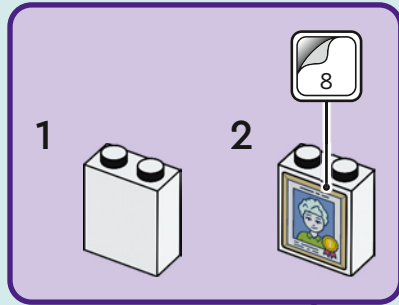



2x



1x

13

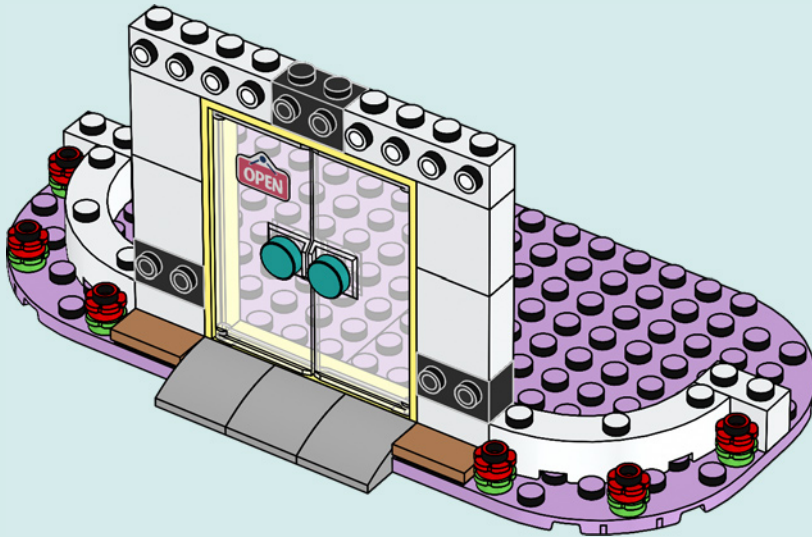

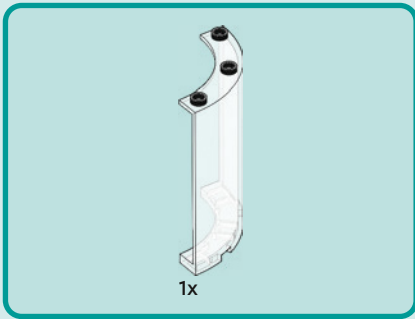

14

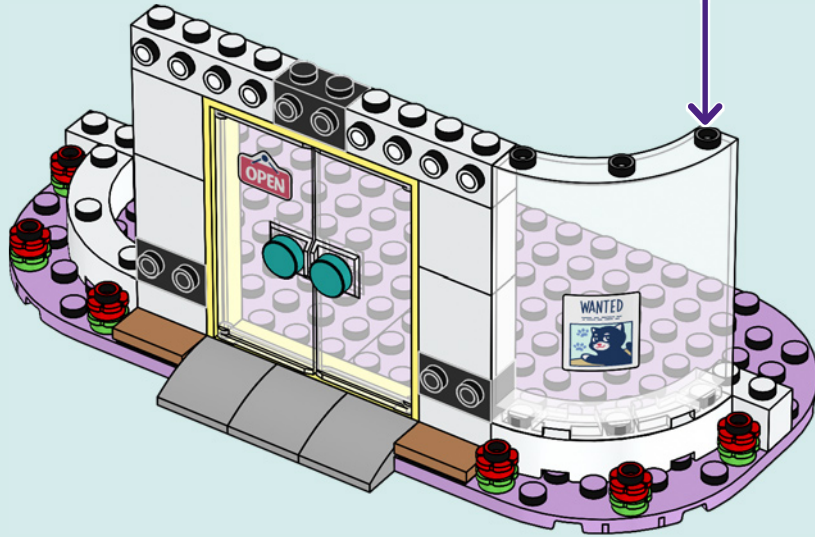
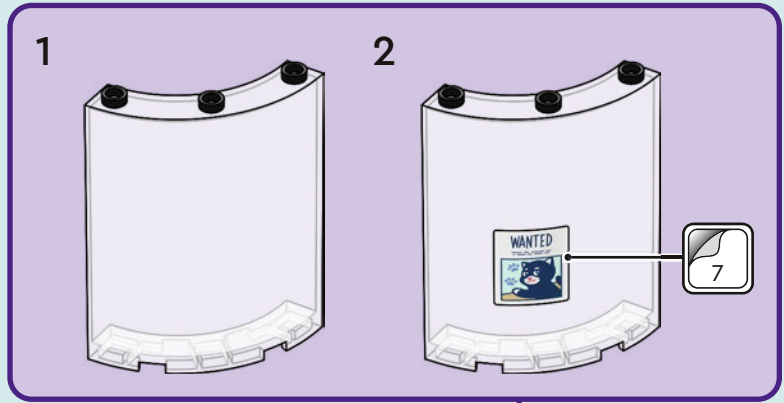



1x

15

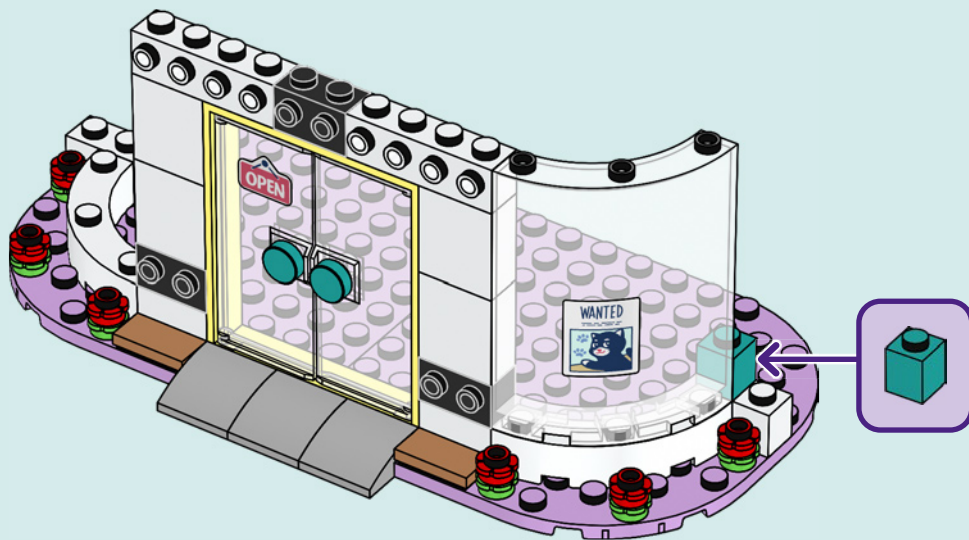

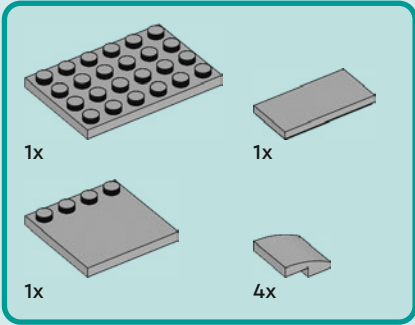
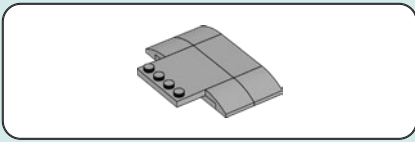

16

1

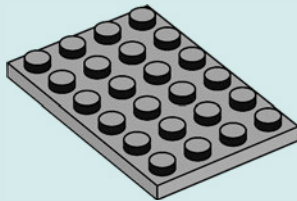

2

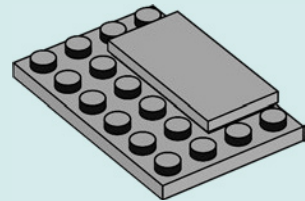

3

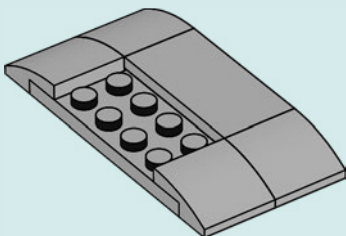

4

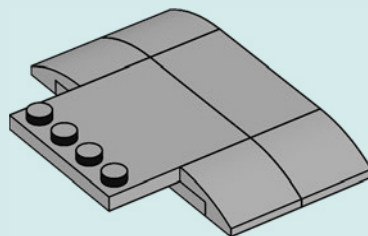

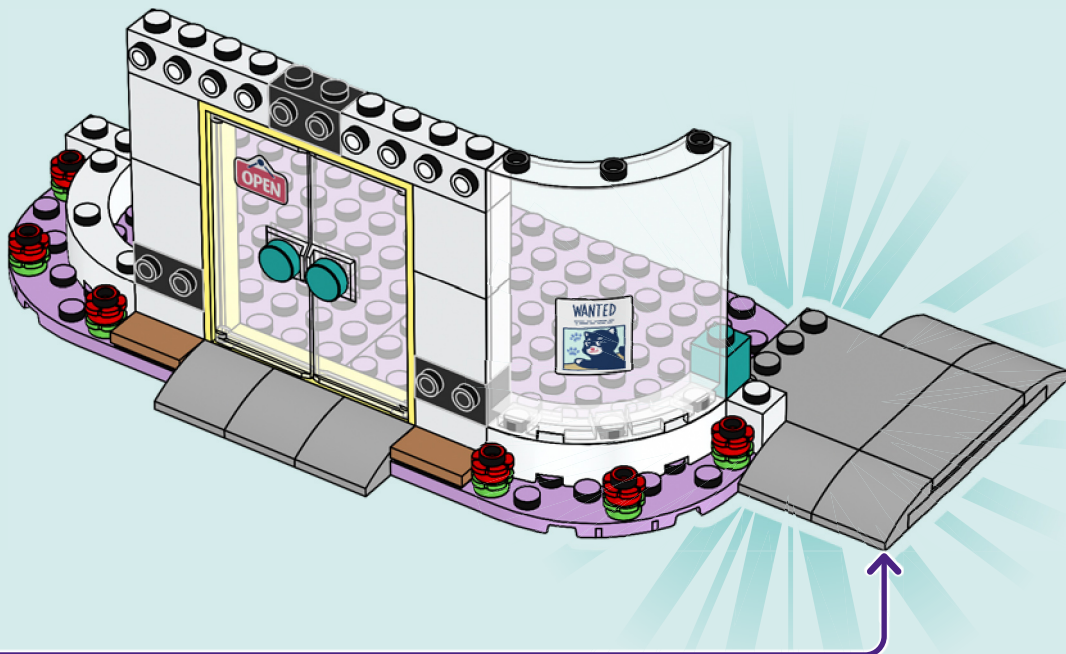

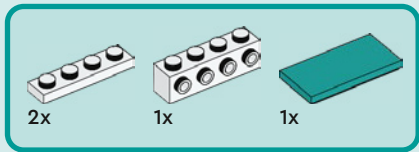

17

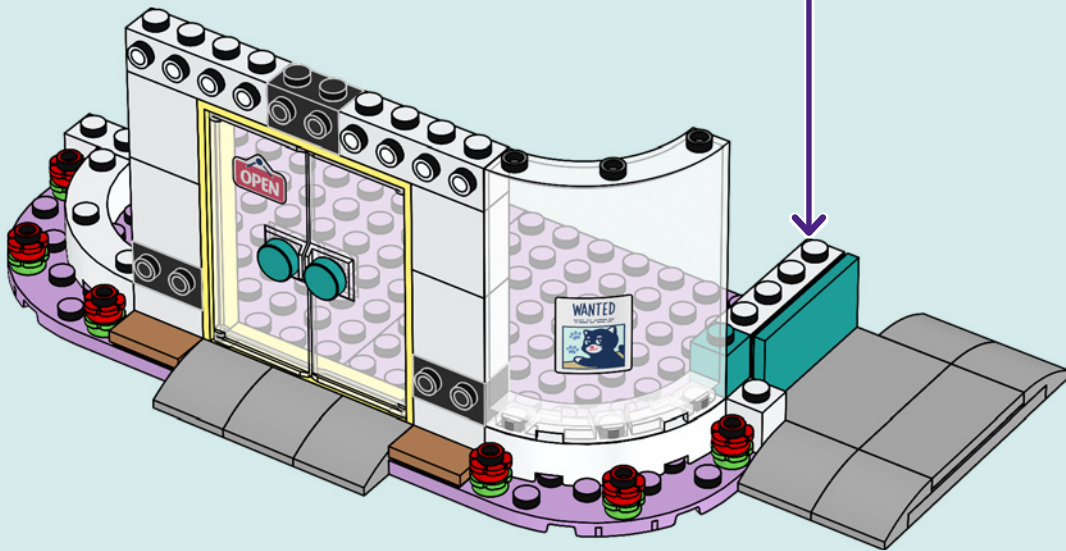
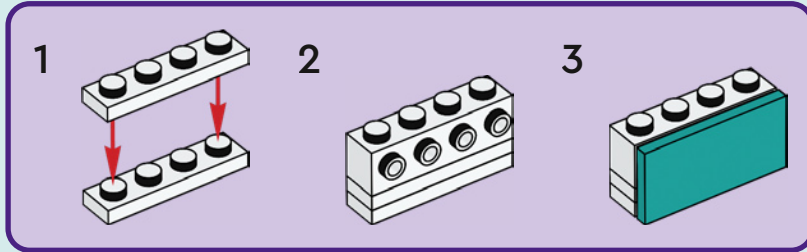



1x



1x

18

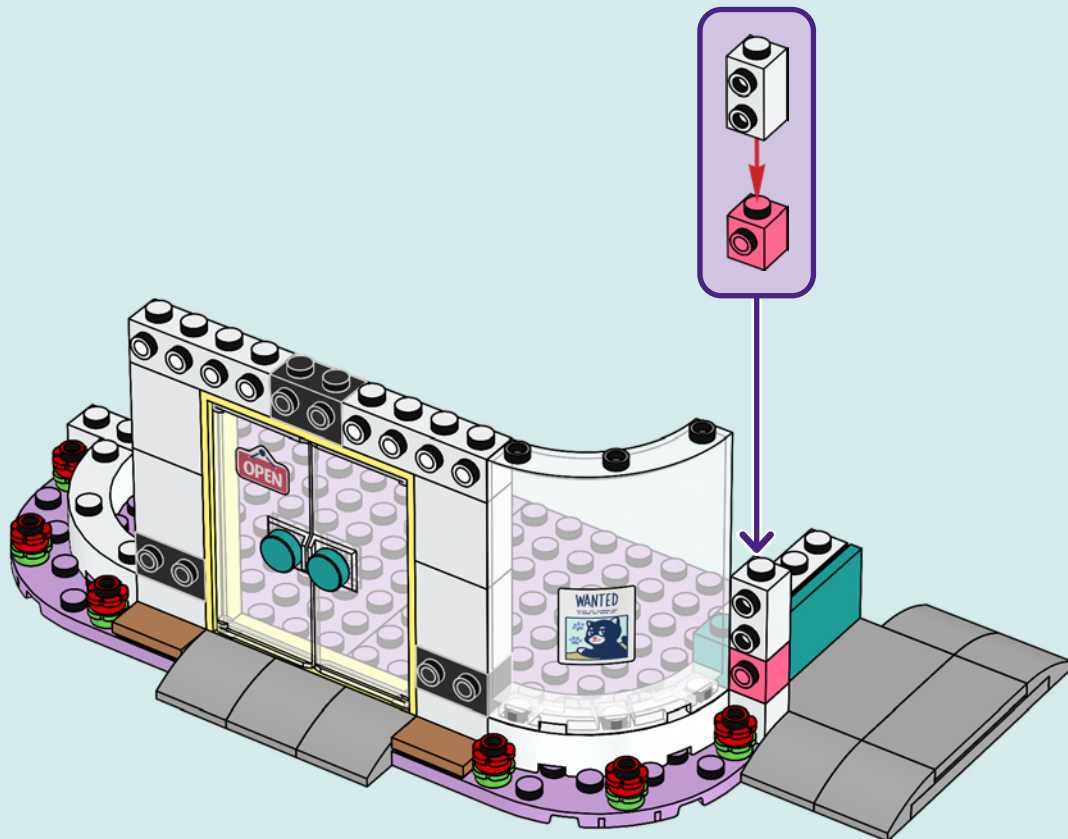



1x

19

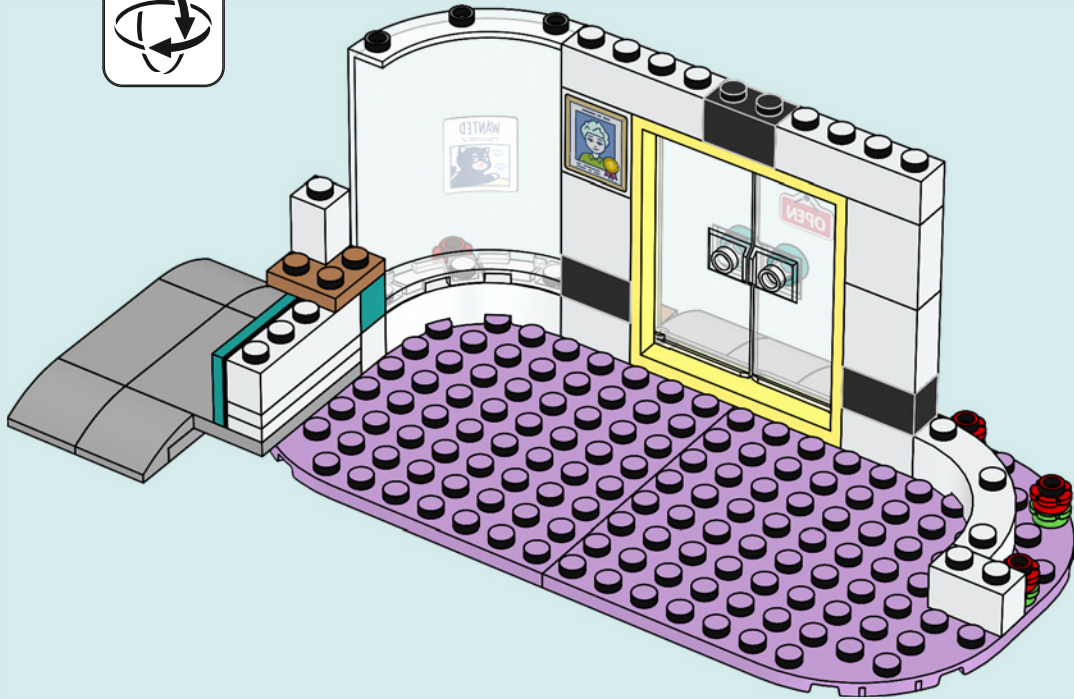



1x



1x

20

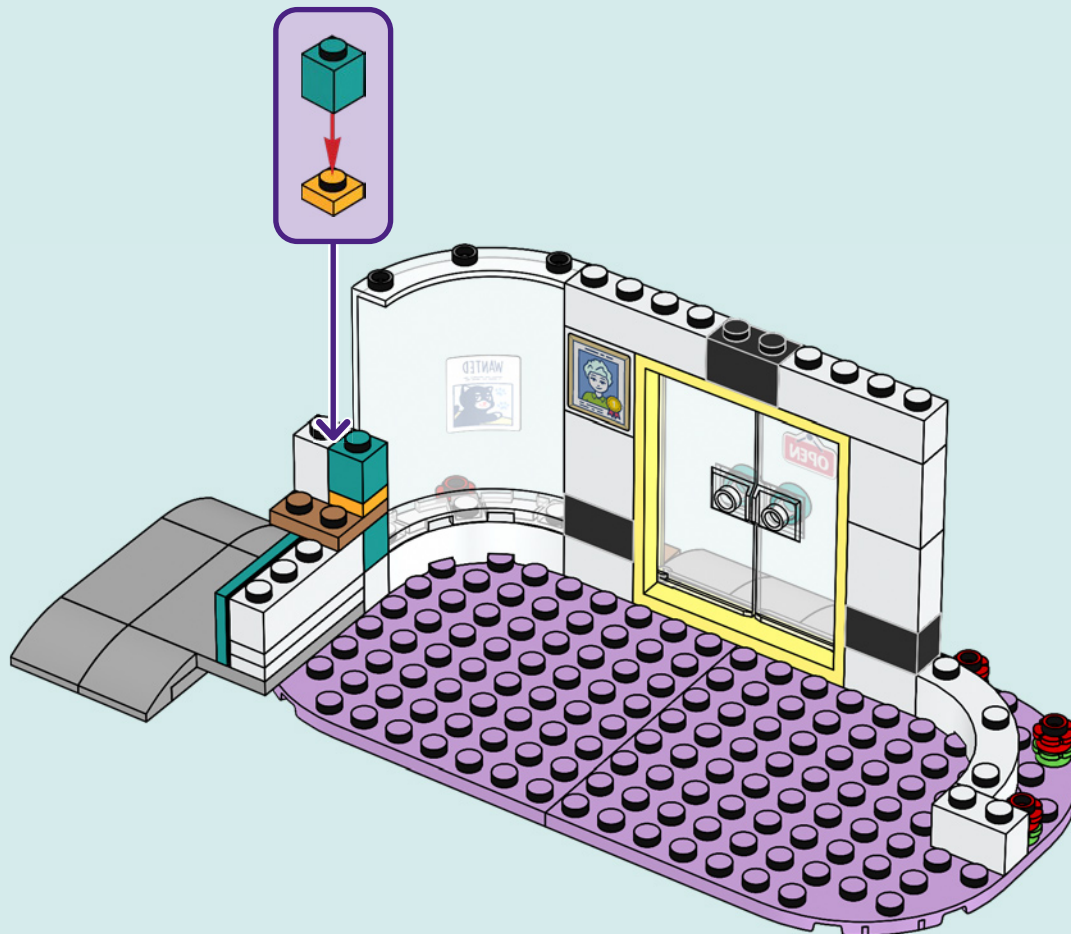



1x



1x

21

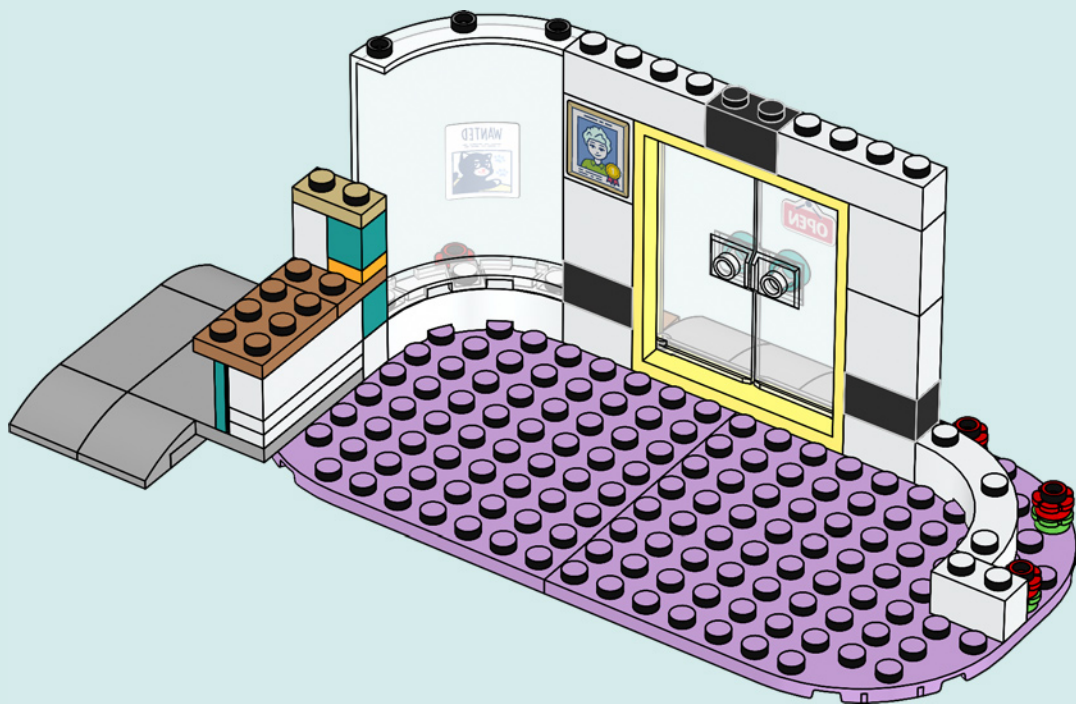

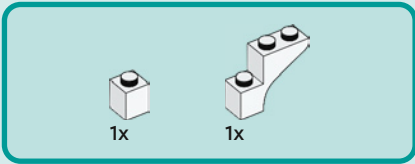

22

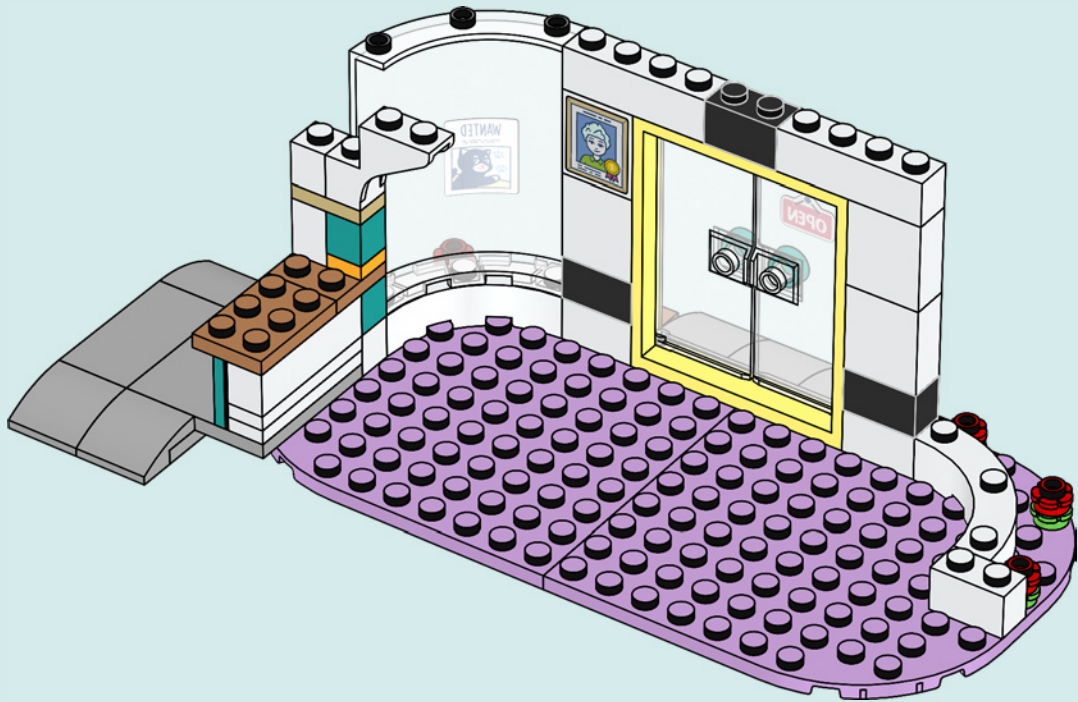



1x

23

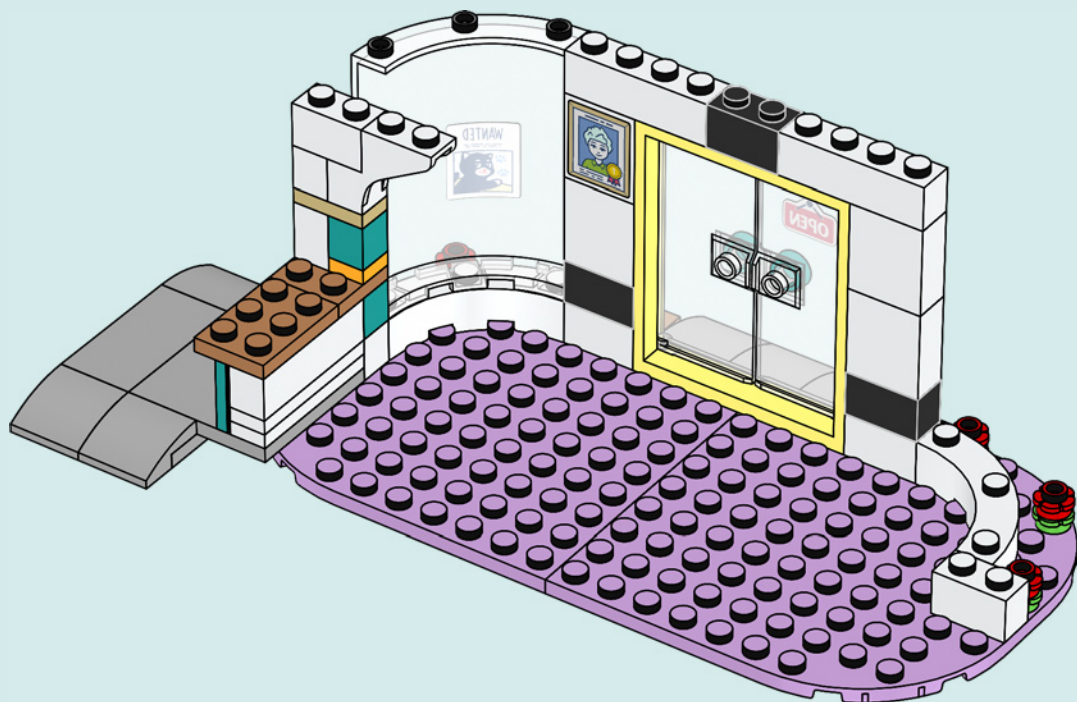

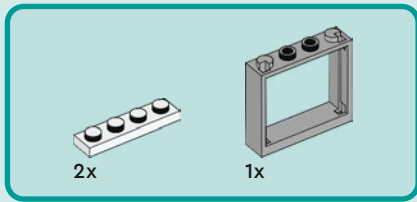

24

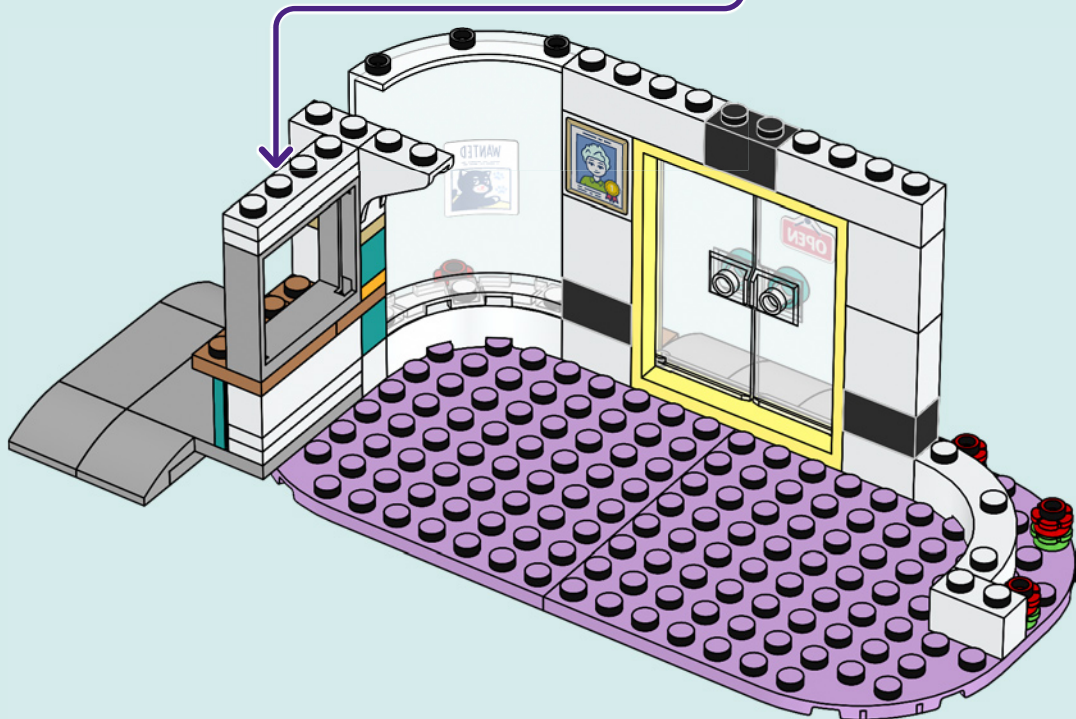
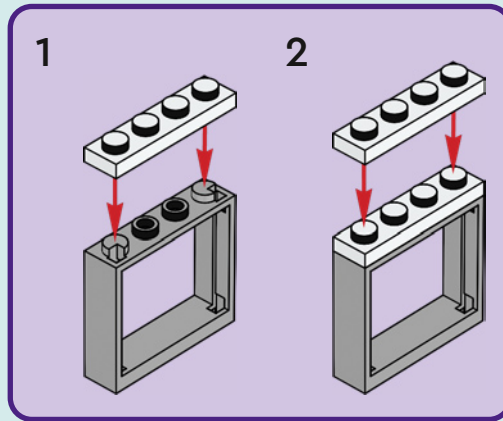



1x



1x



1x

25

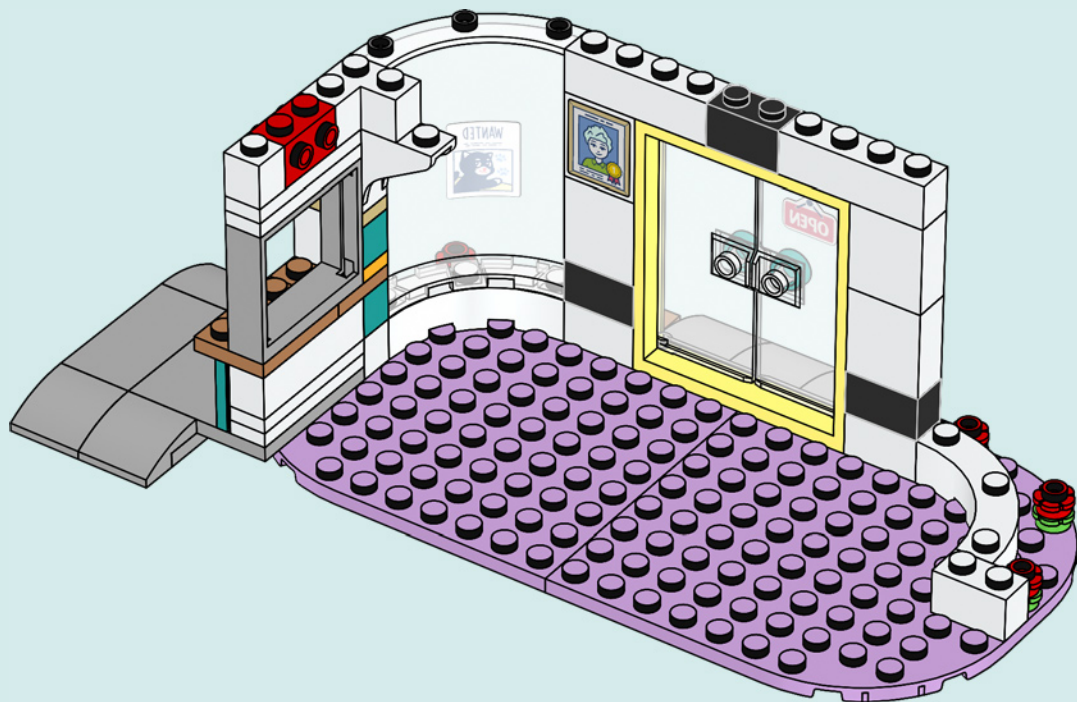

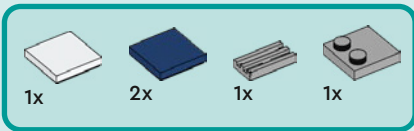

26

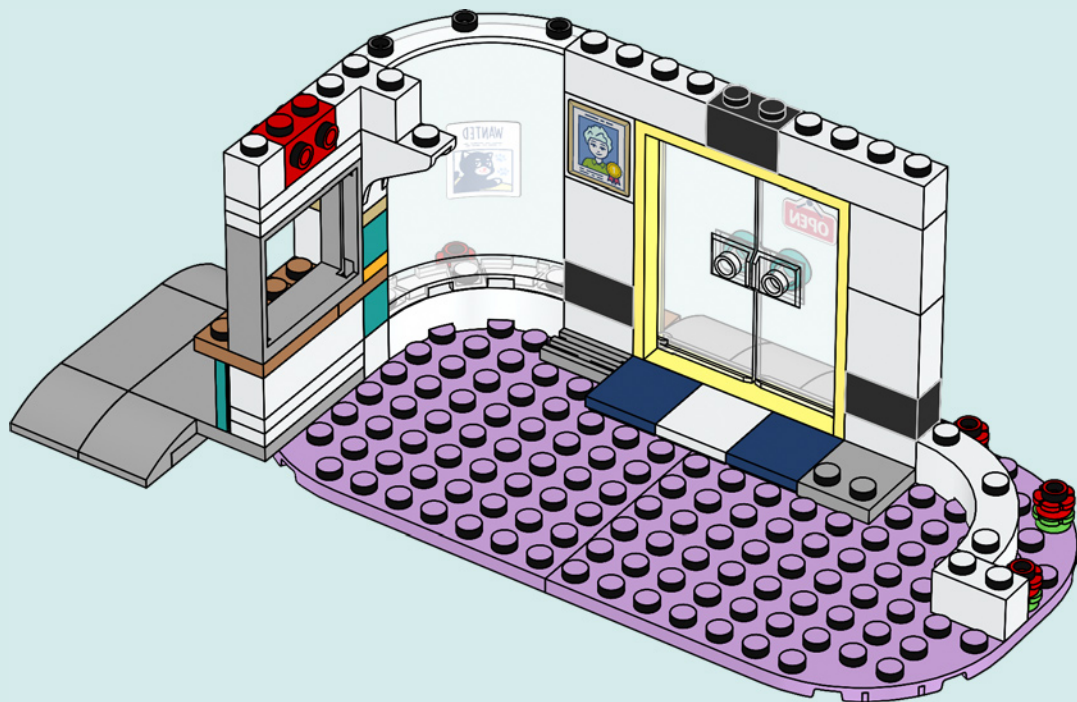



2x



1x

27

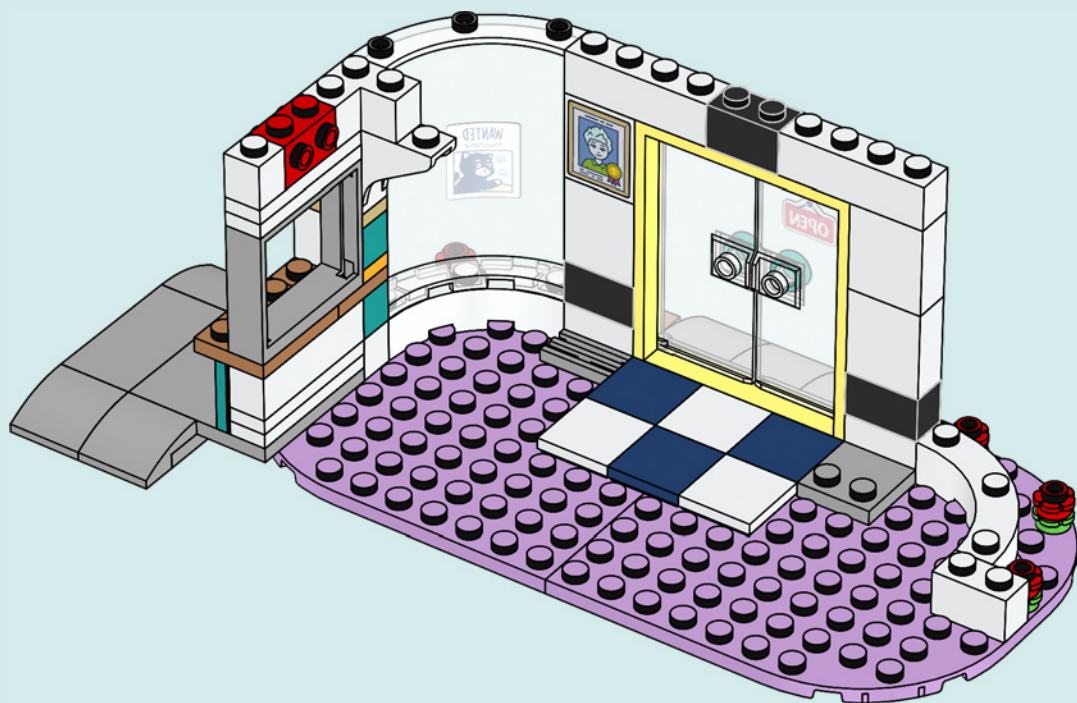



1x



2x

28

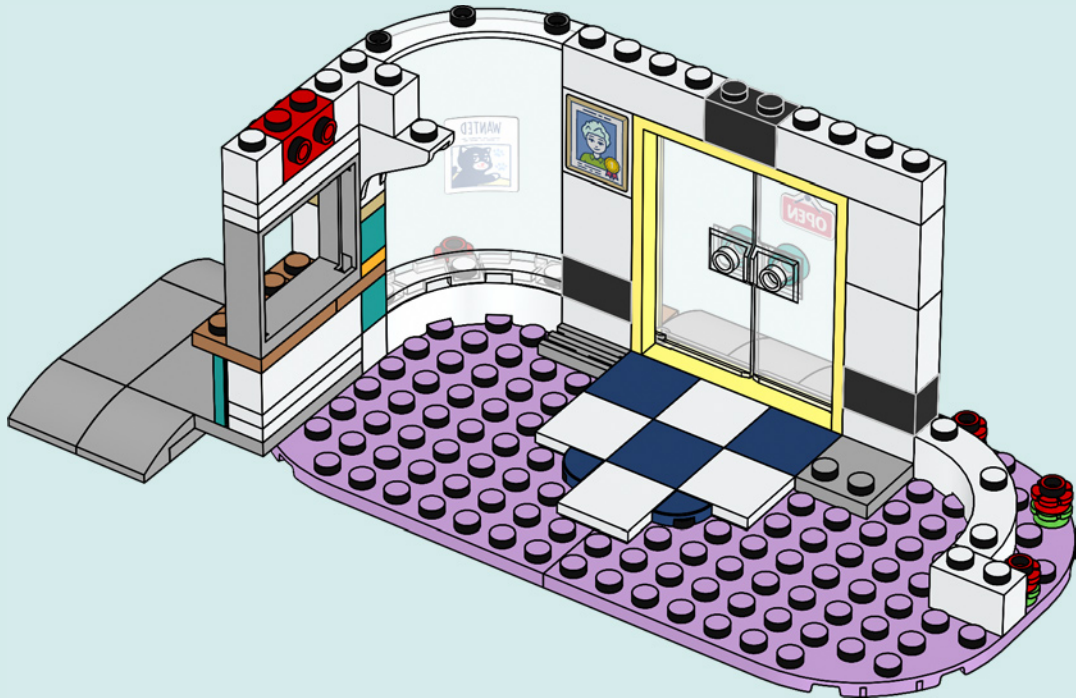



2x

29

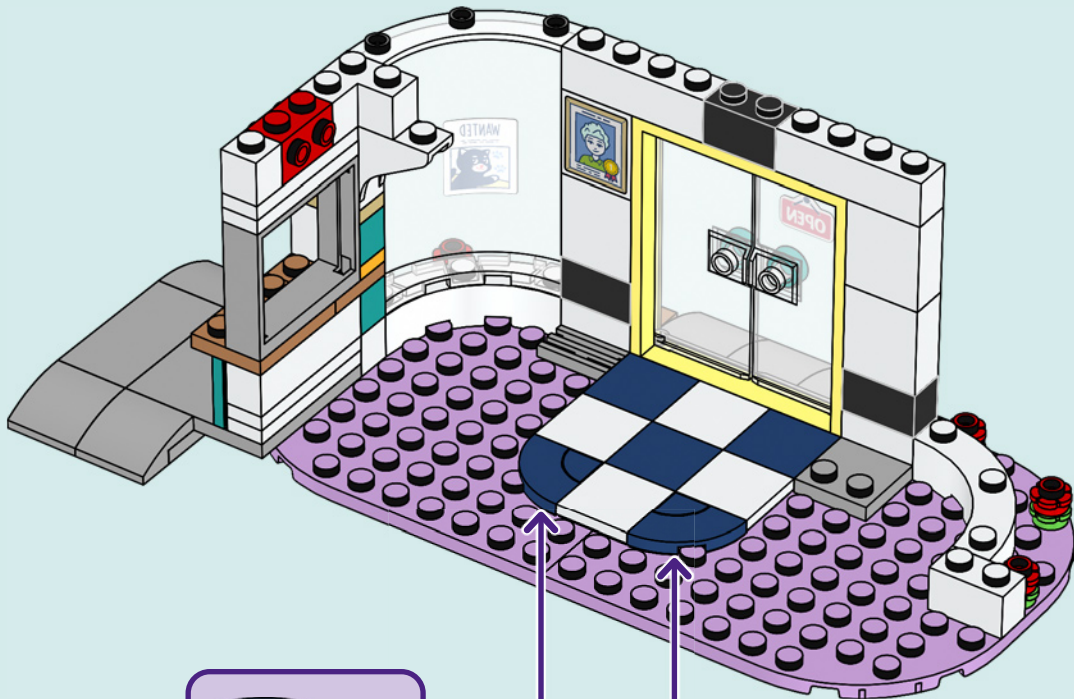

2x





1x



1x

30

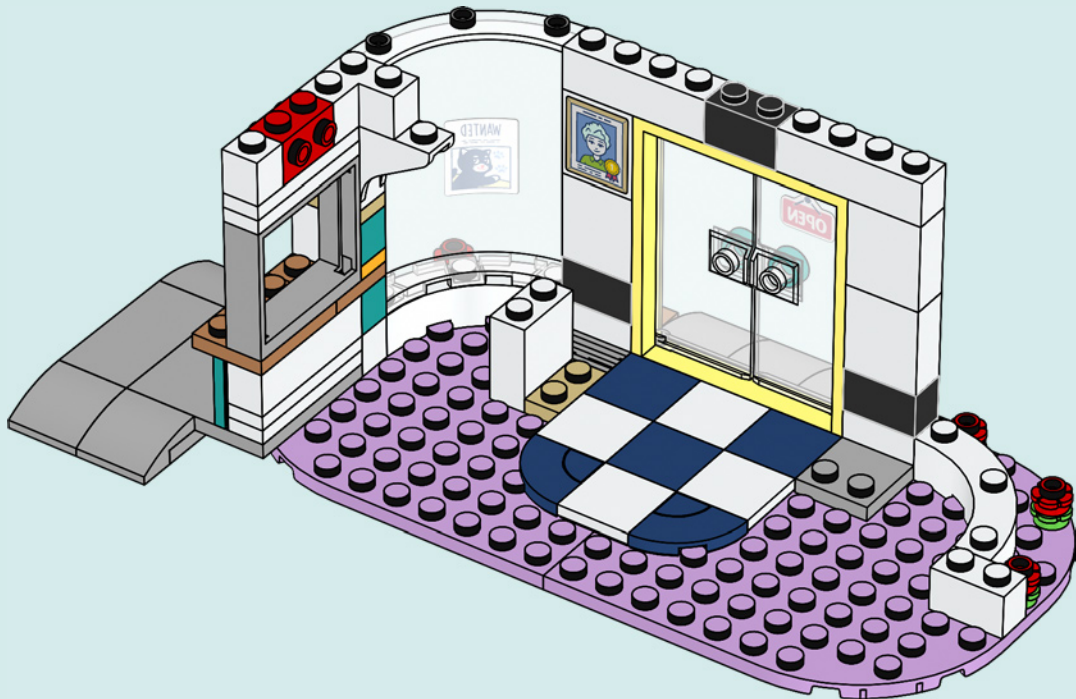



1x

31

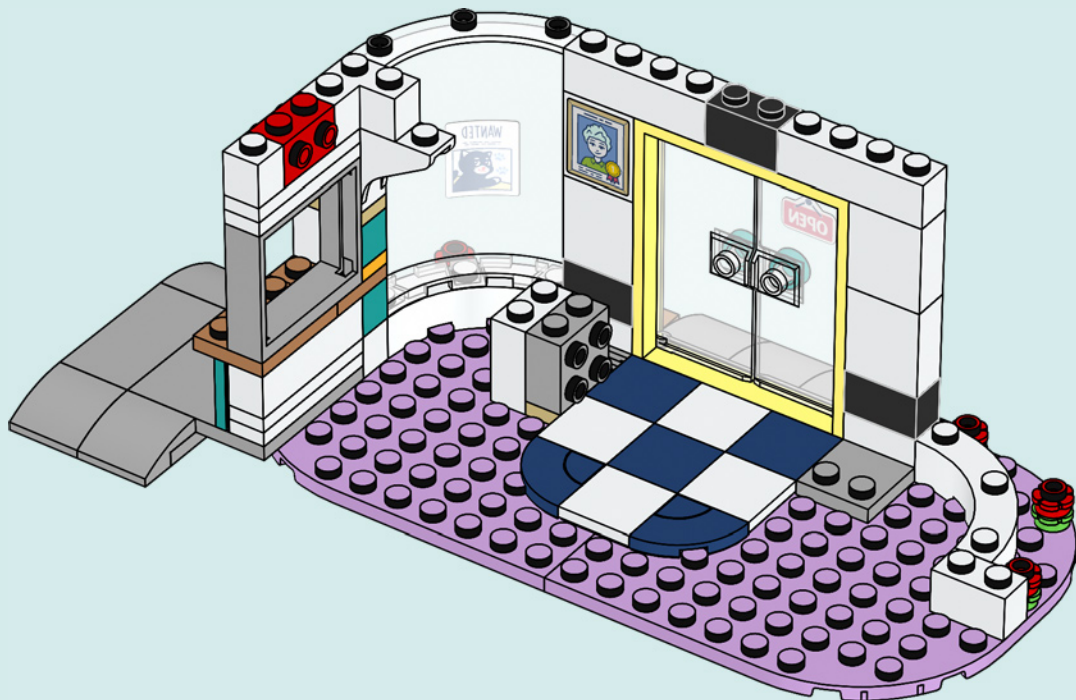

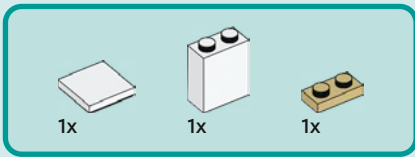

32

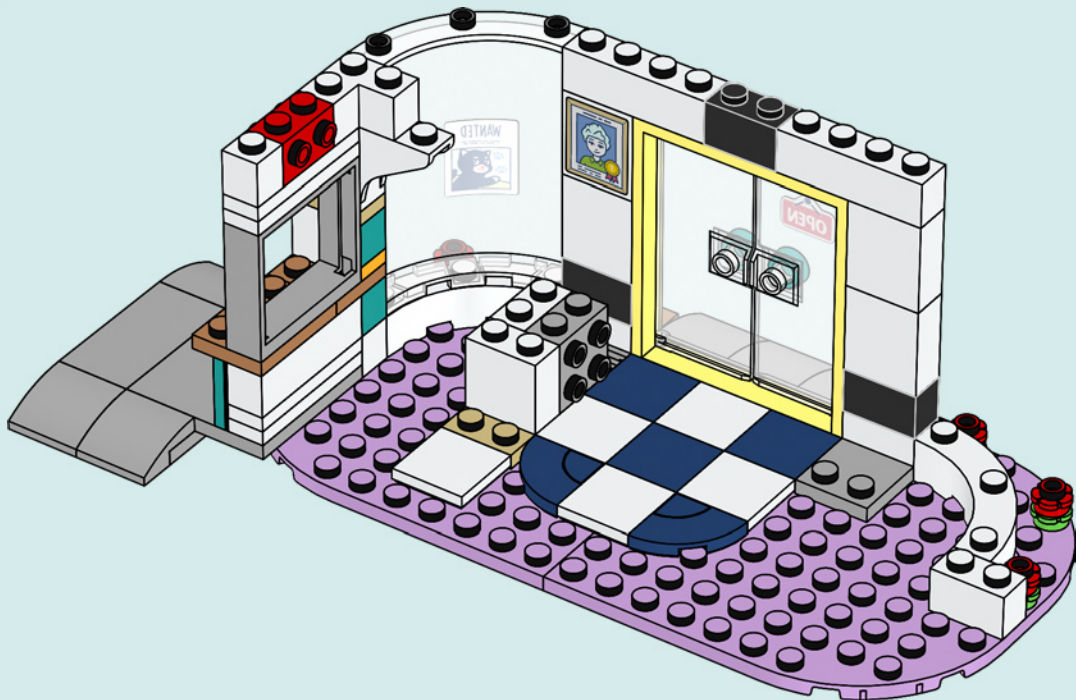



1x



2x

33

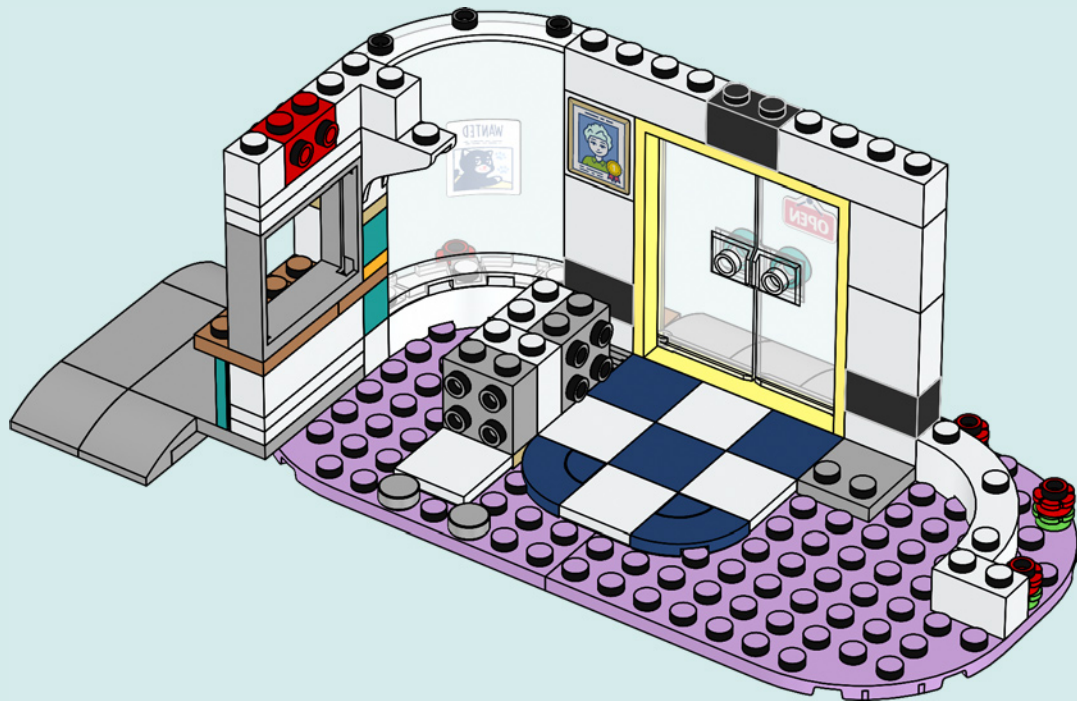



1x

34

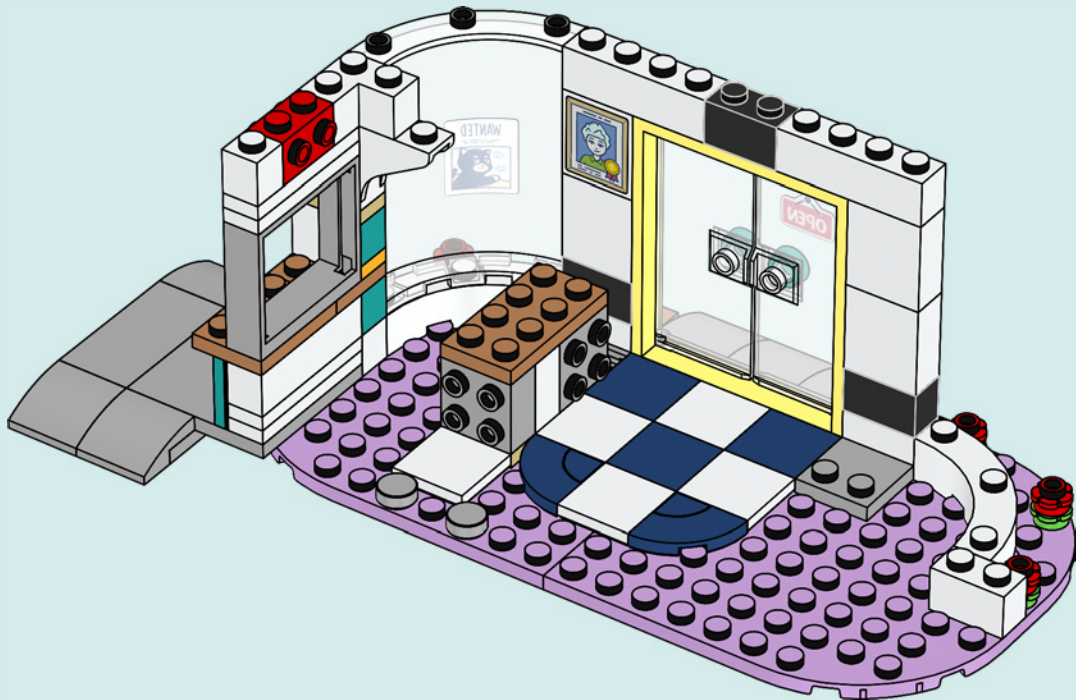

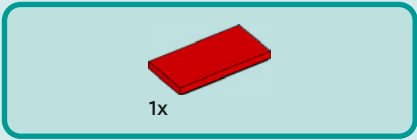

35

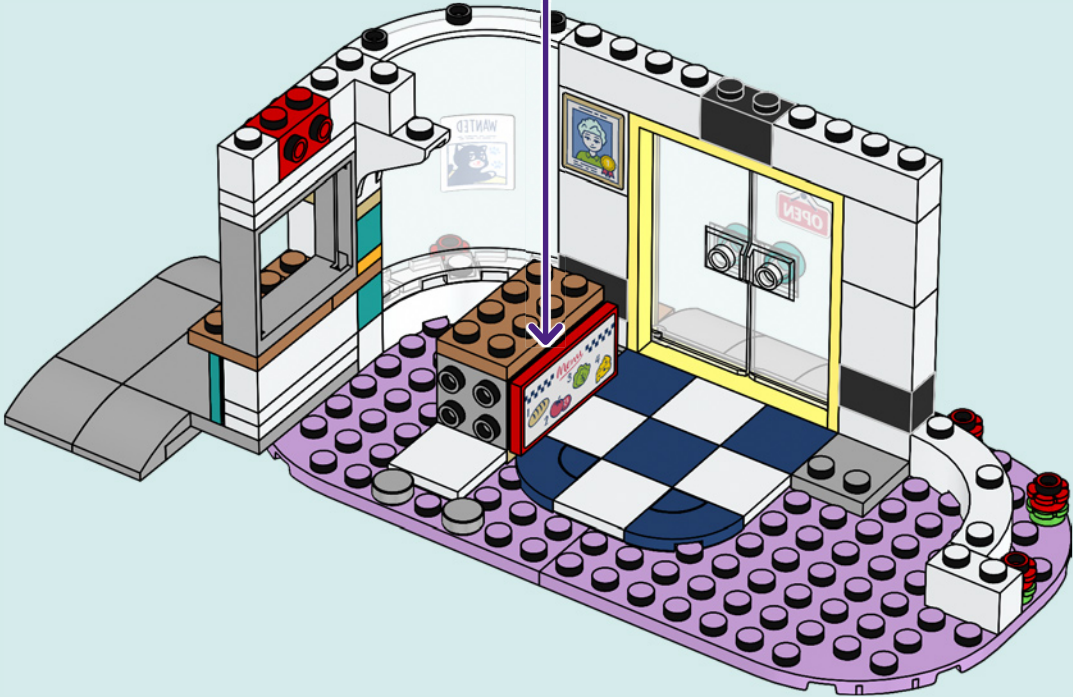
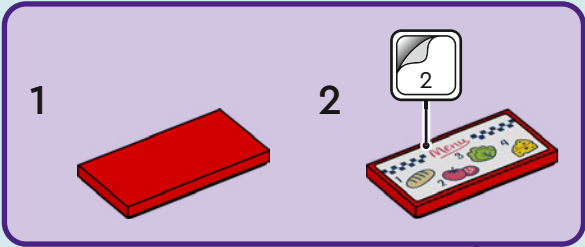



1x



1x

36

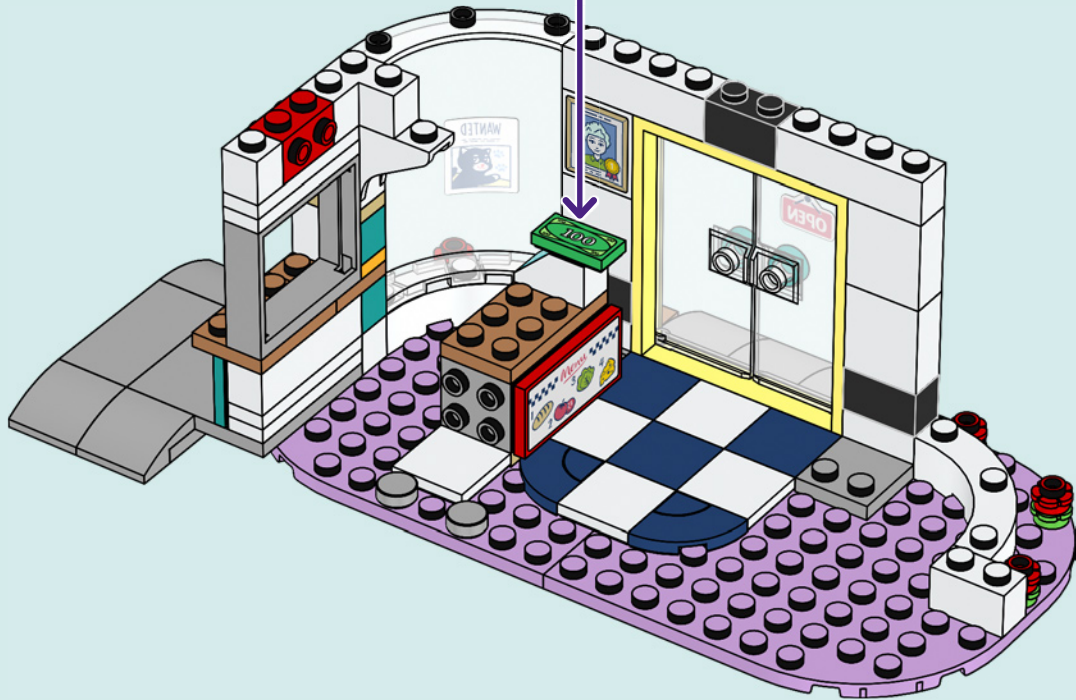
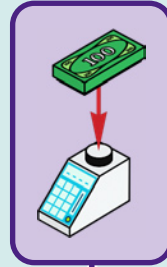



2x



4x

37

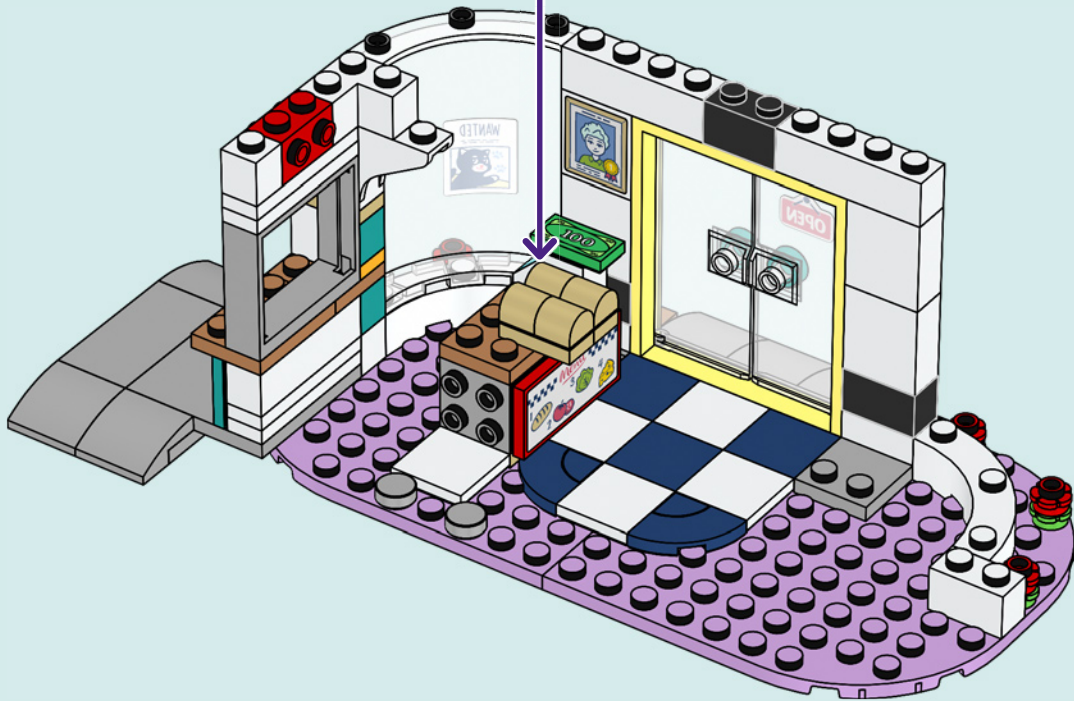
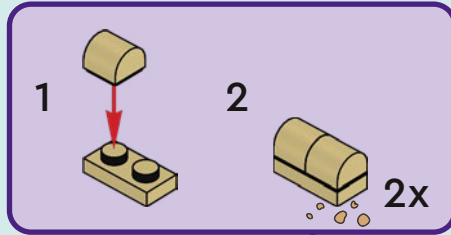

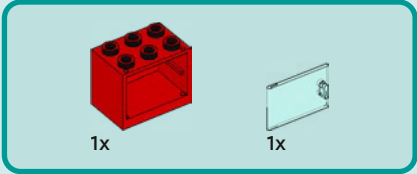

38

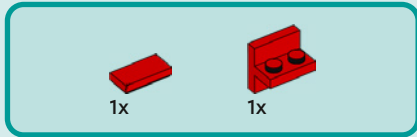
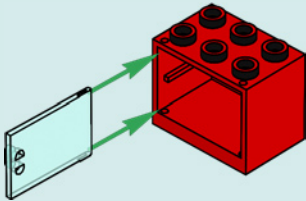

39

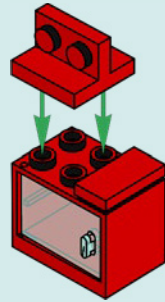



40

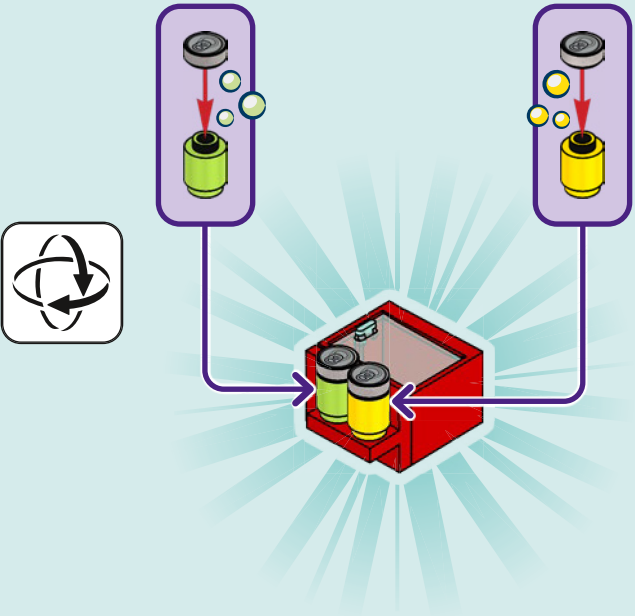

41

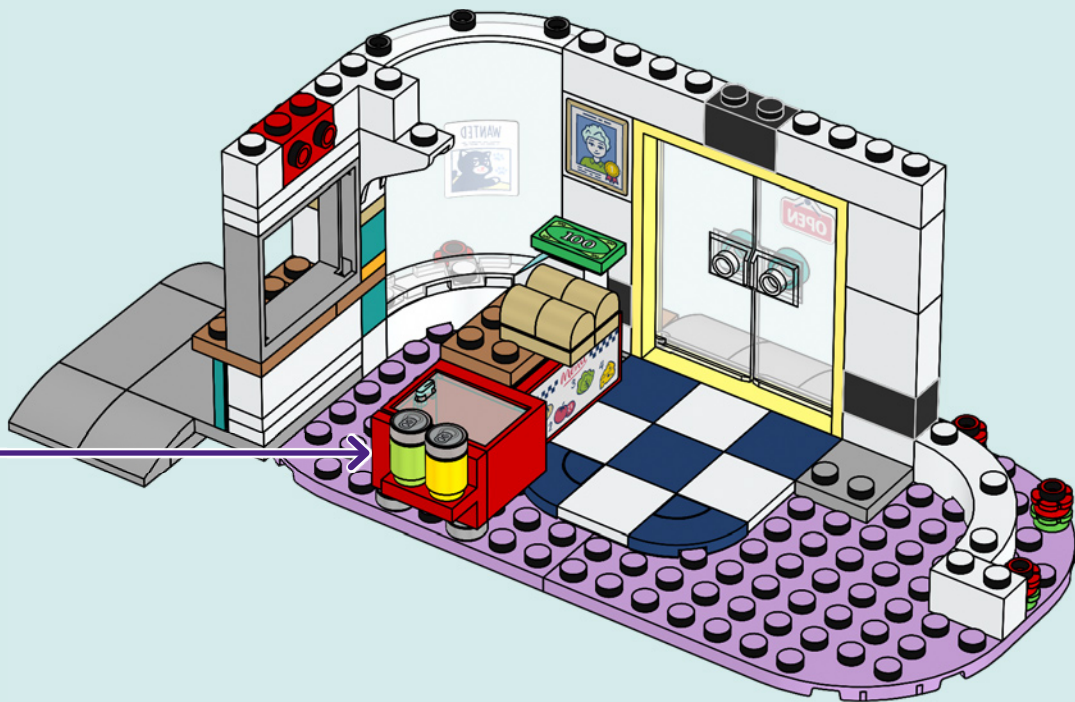

42



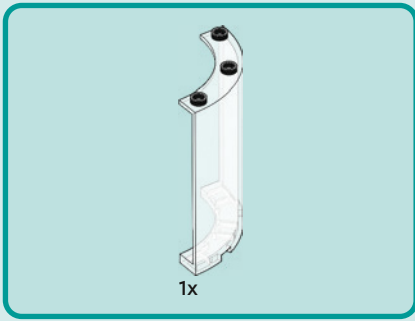

43





1x

44



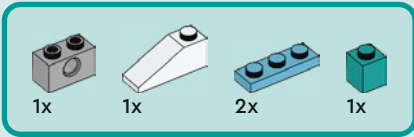

45

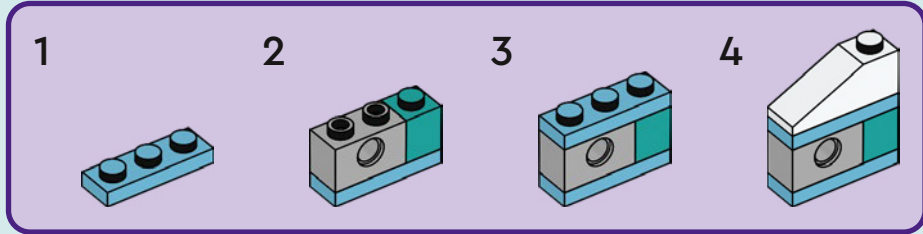



1x

1x

46





1x

47



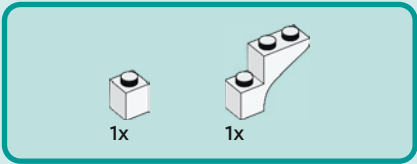

48





1x

49



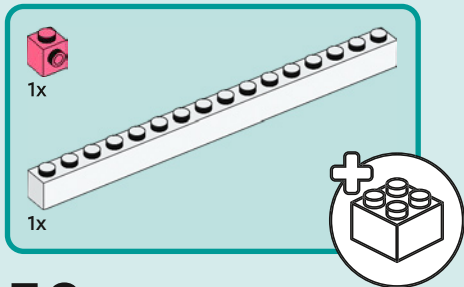

50

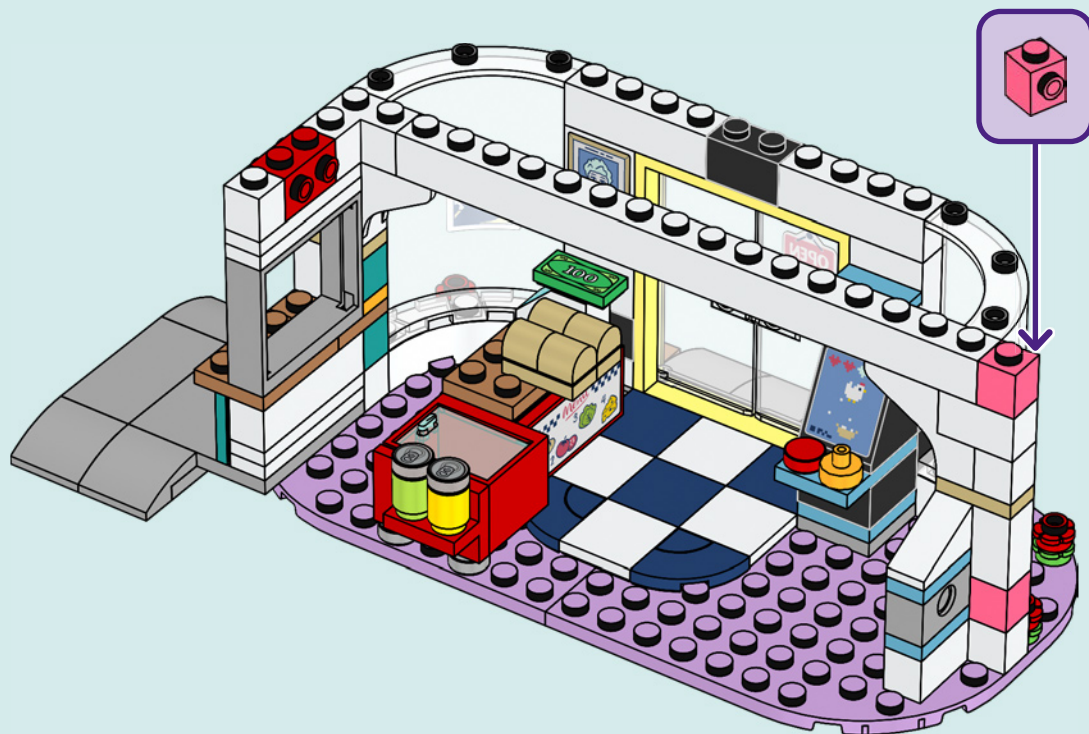



1x



1x

51

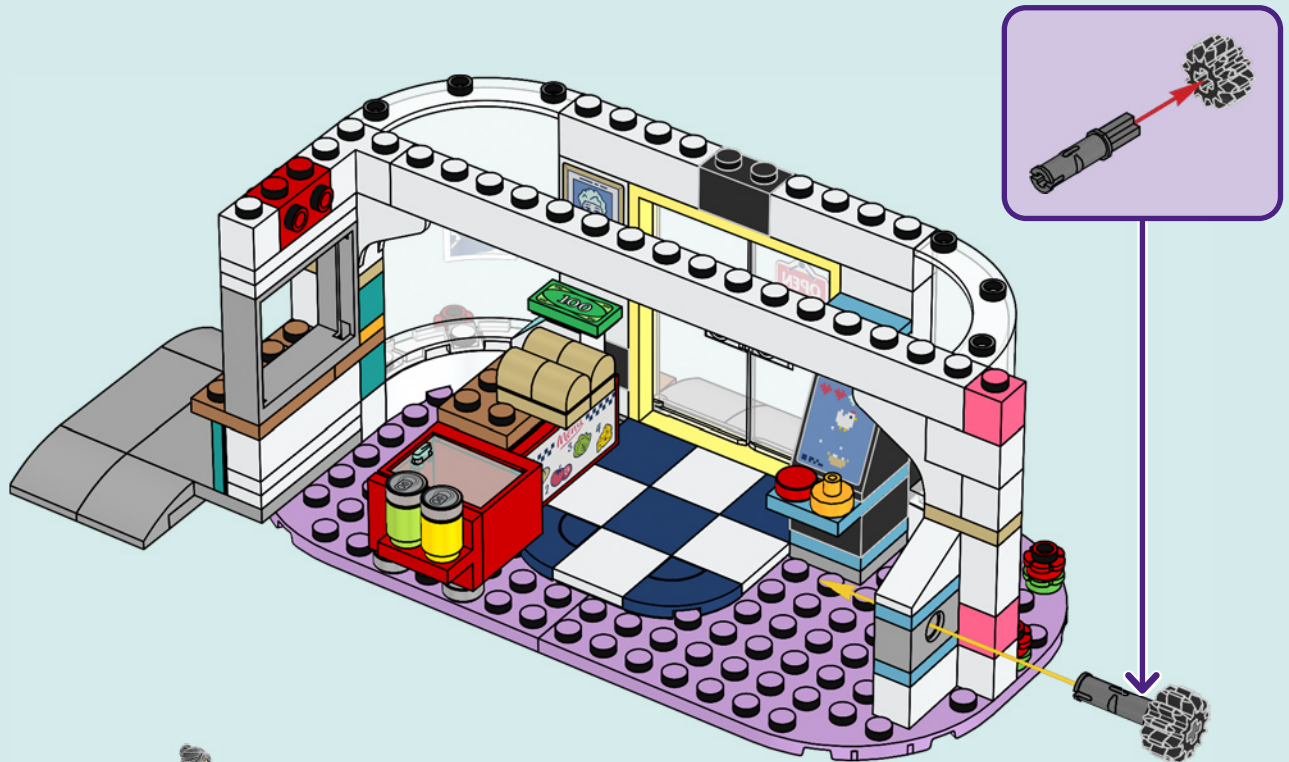

52

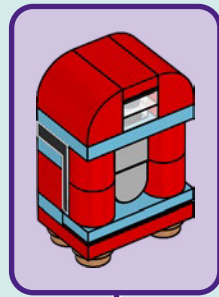

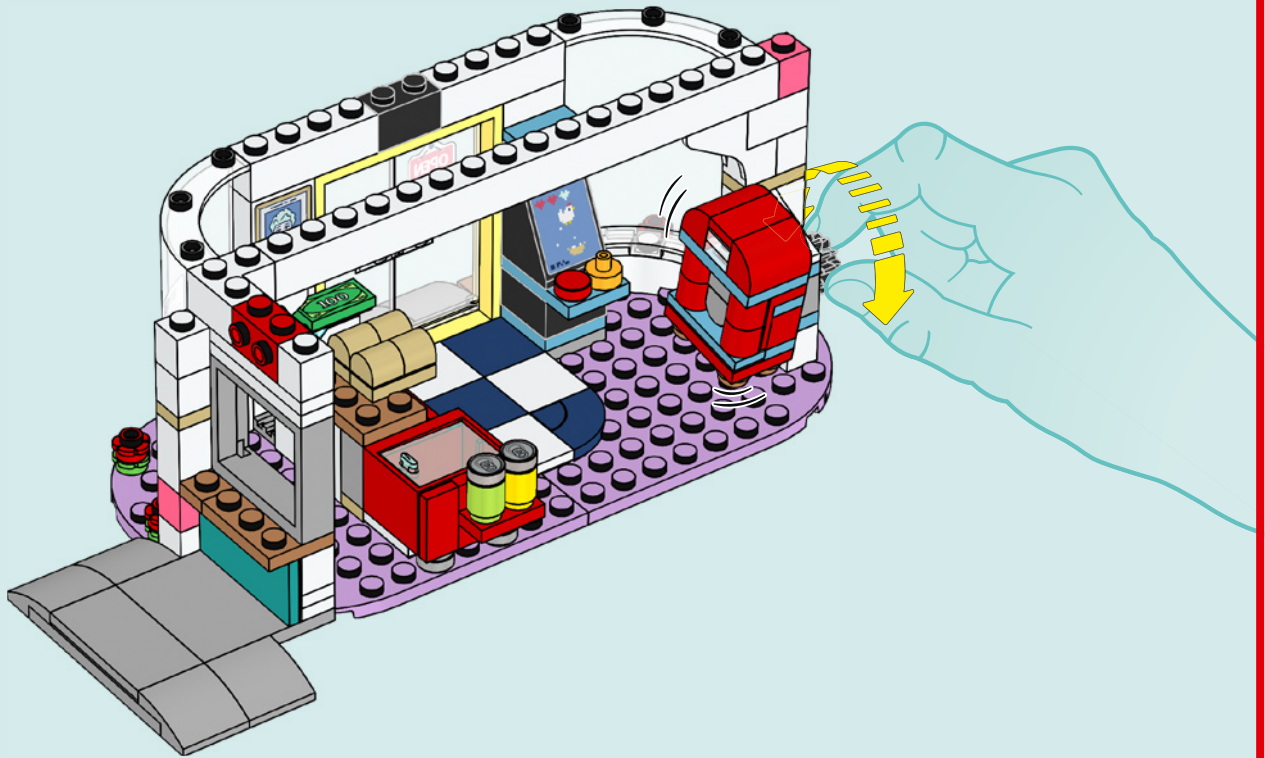



1x

53

1

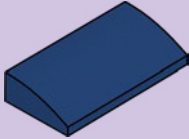

2

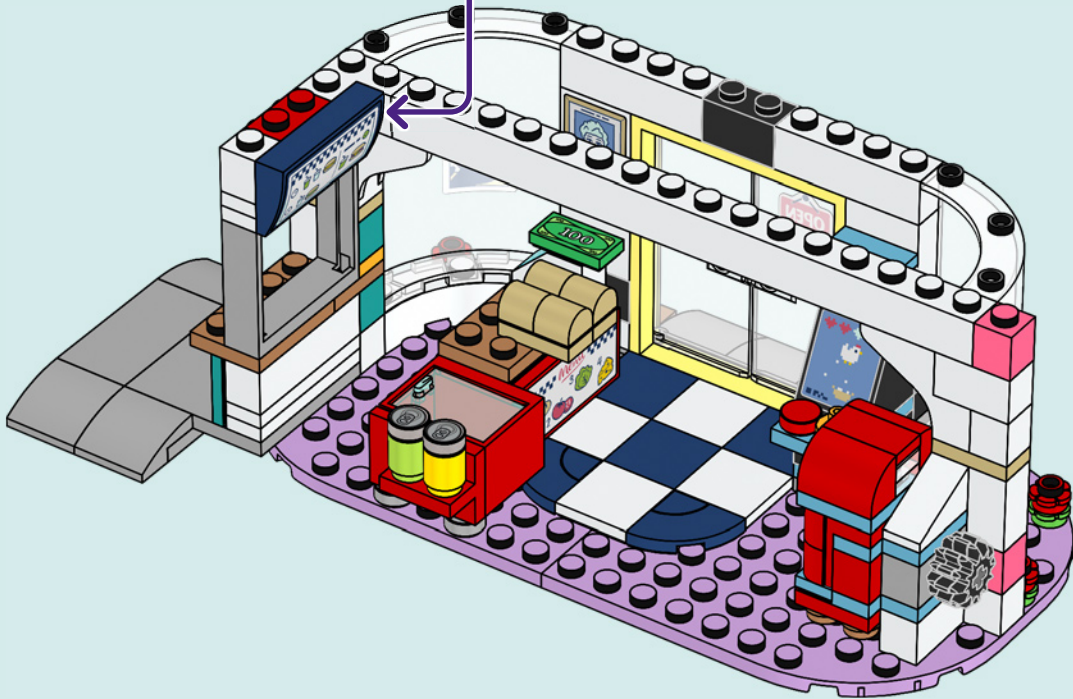
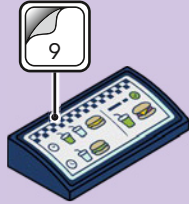



1x

54

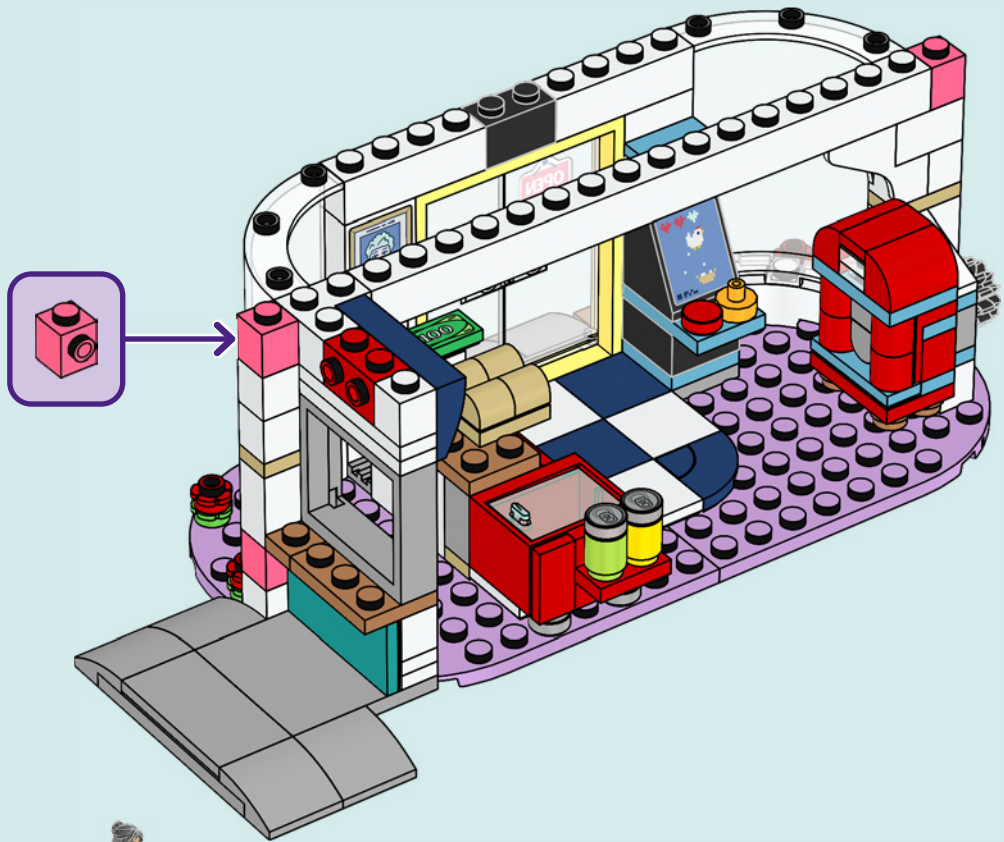

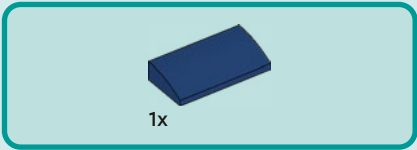

55

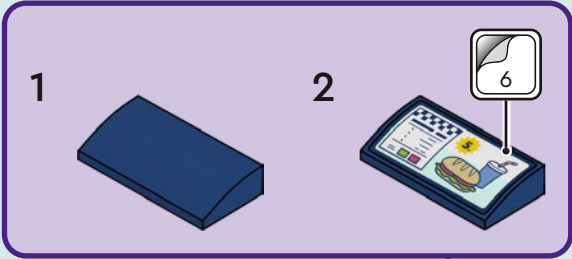

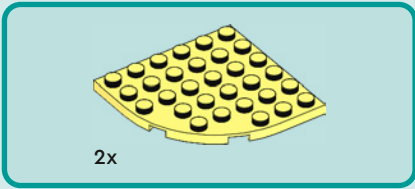

56

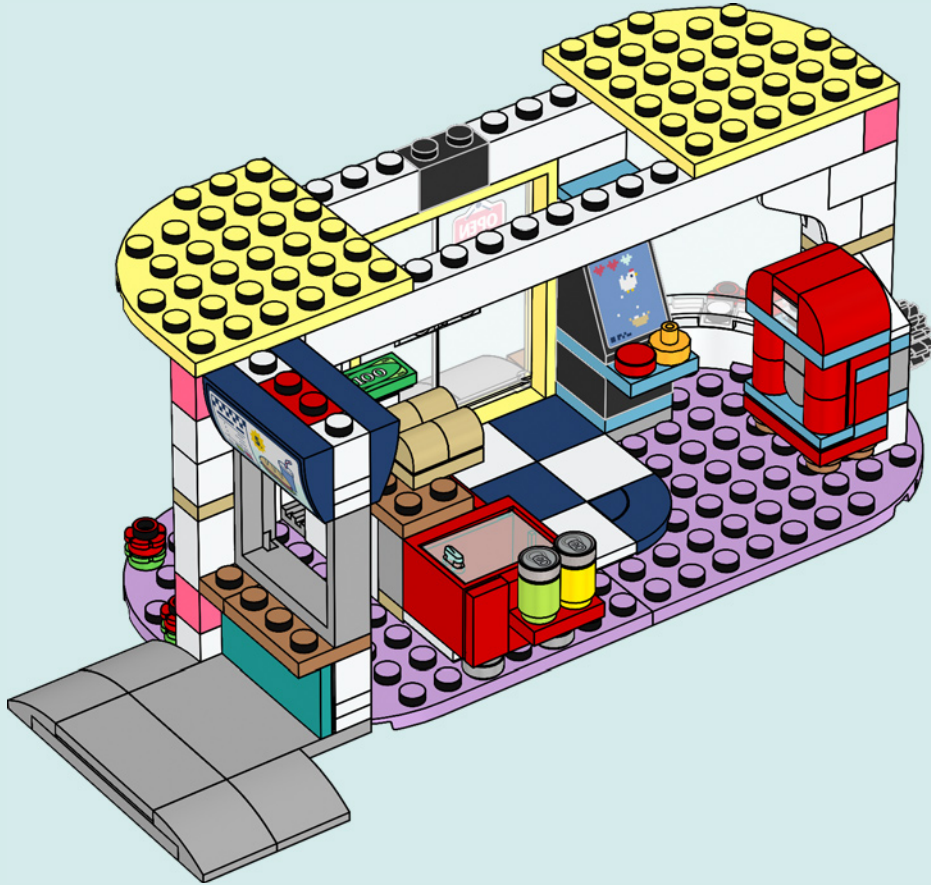



1x

57



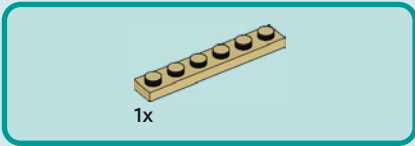

58

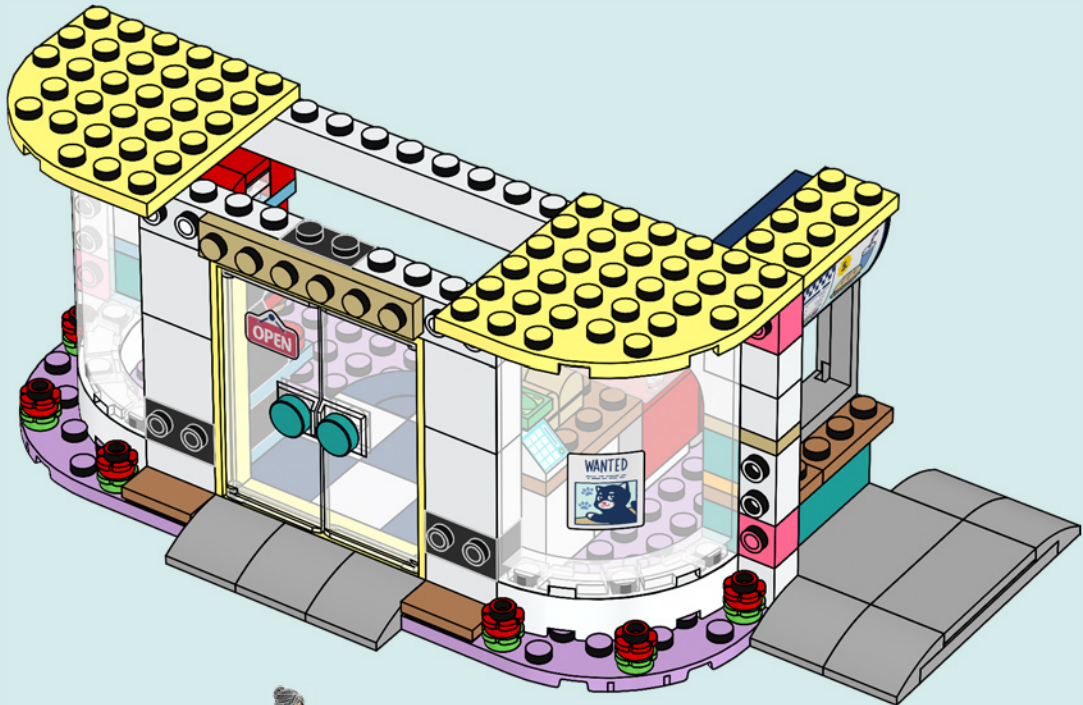

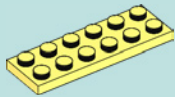

4x

59

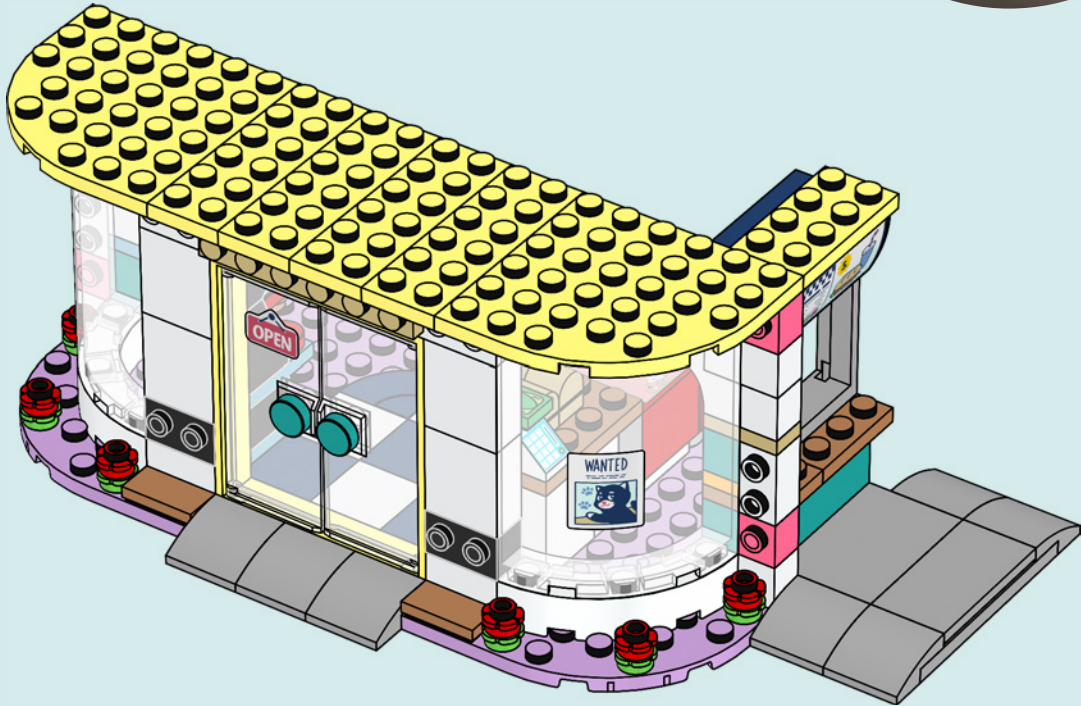



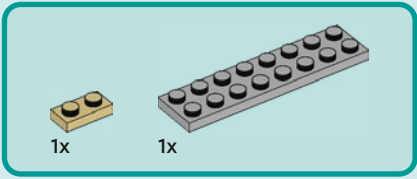

60

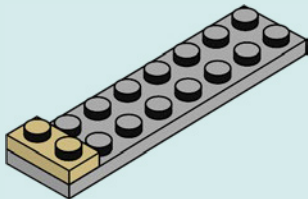

61

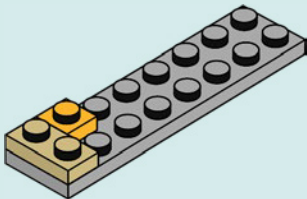



5x

62

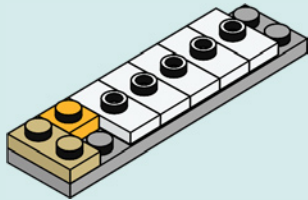

1x



1x



1x

63

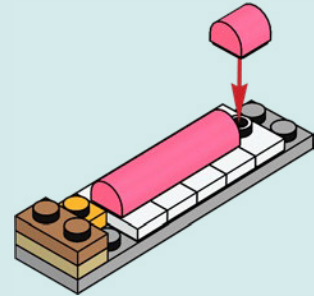



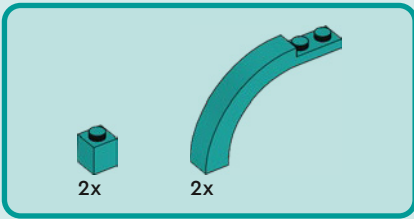

65

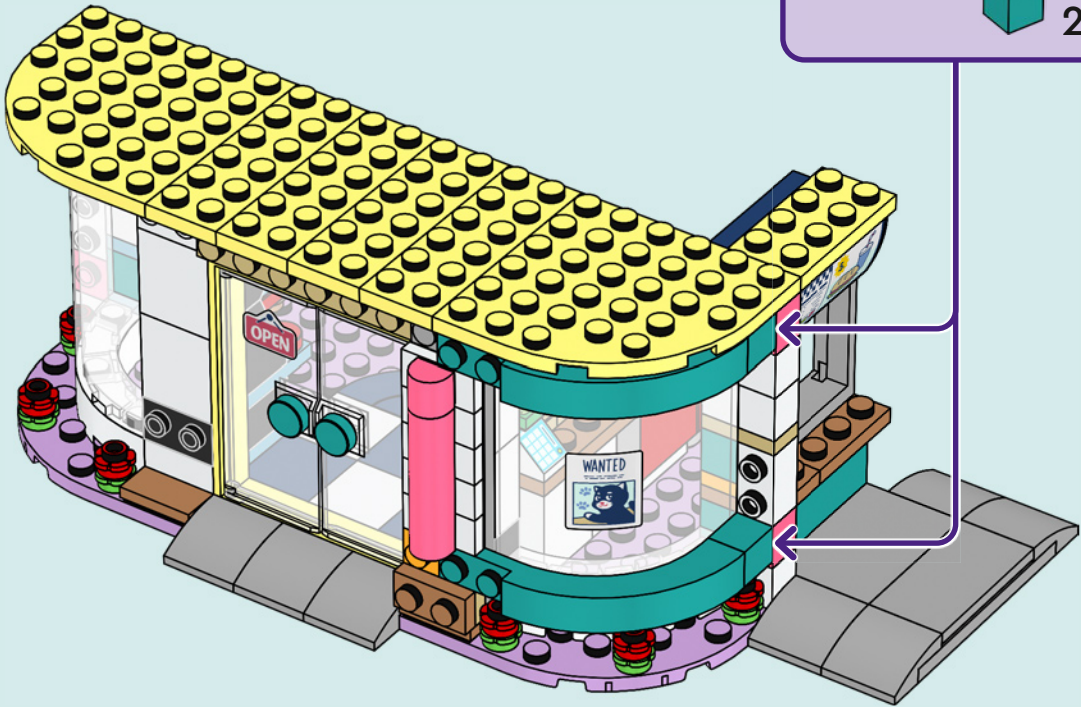
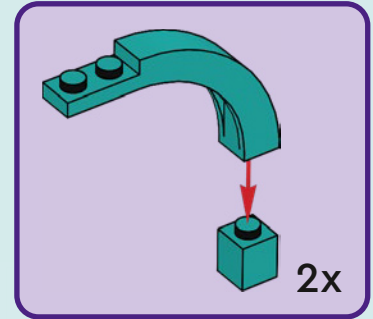

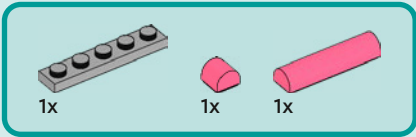

66

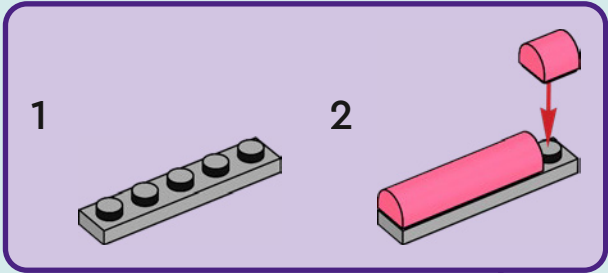

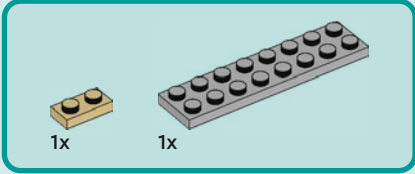
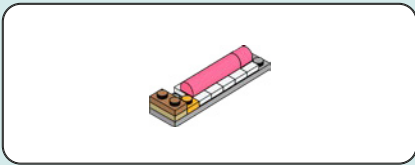

67

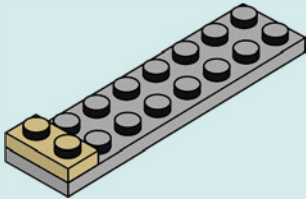

68

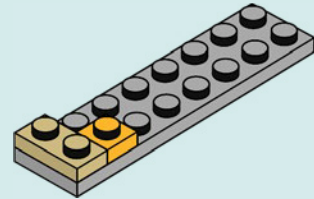



5x

69

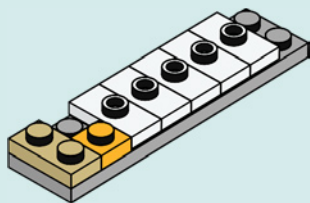

1x



1x



1x

70

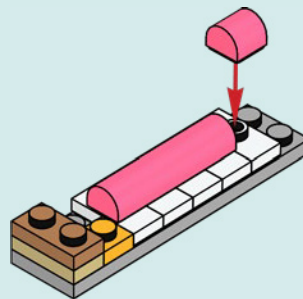

71



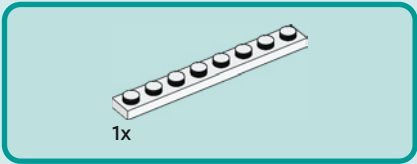

72

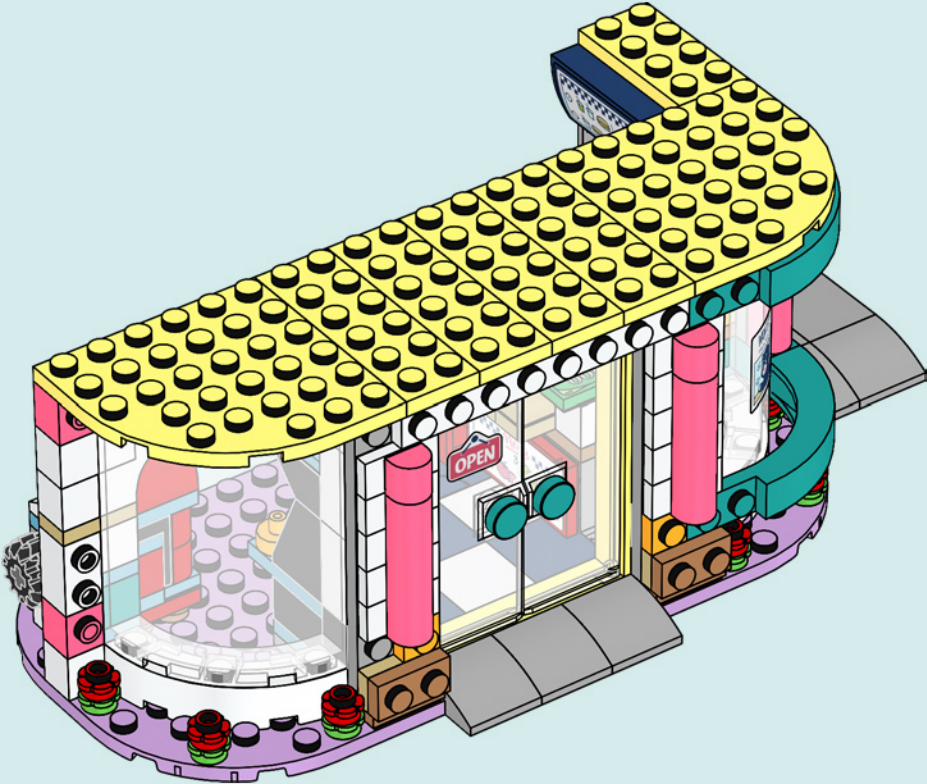

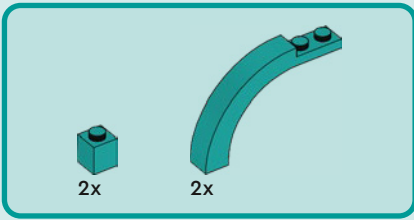

73

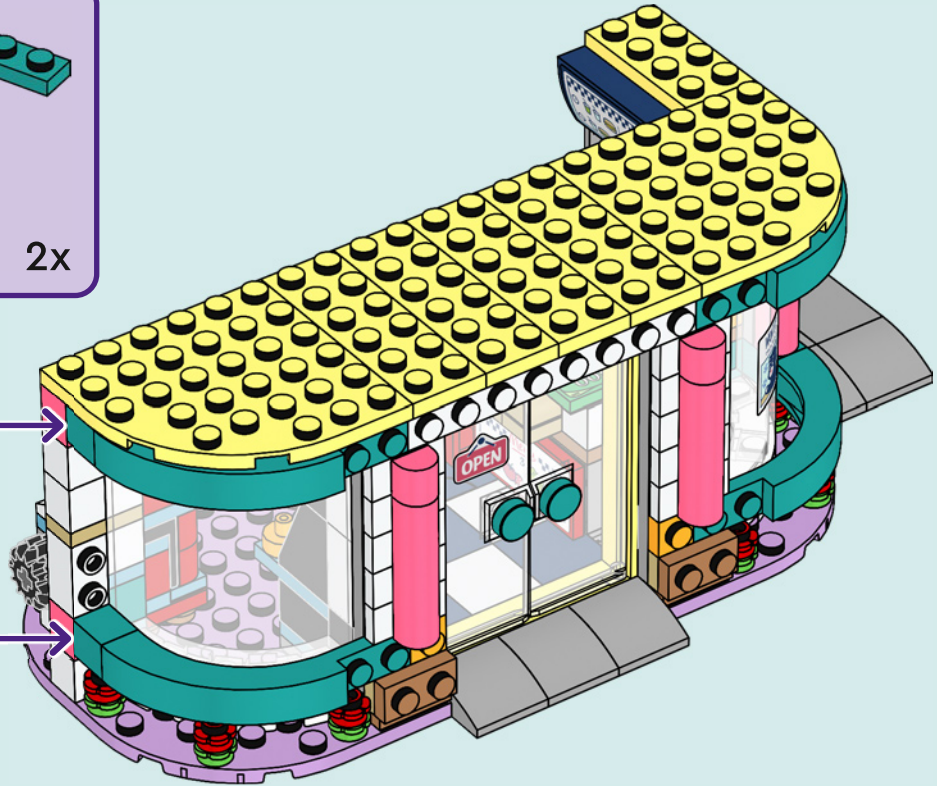
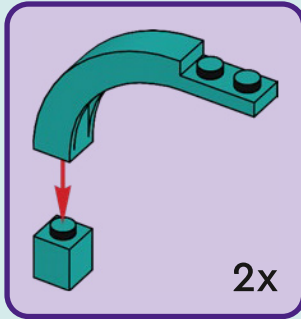

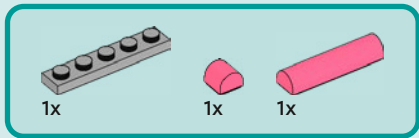

74

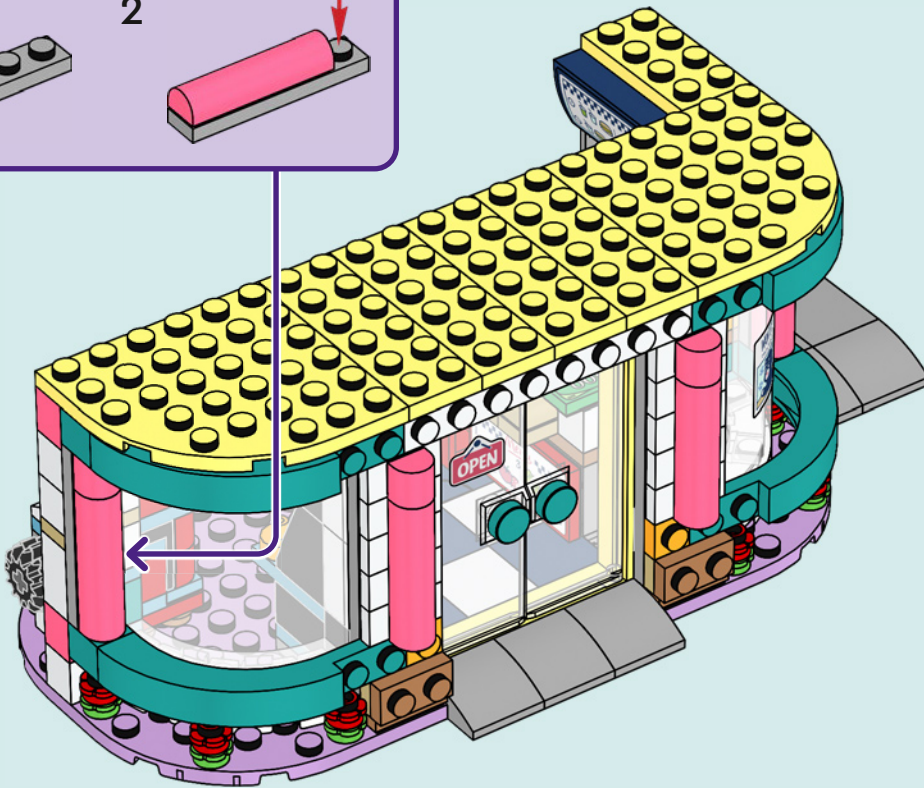
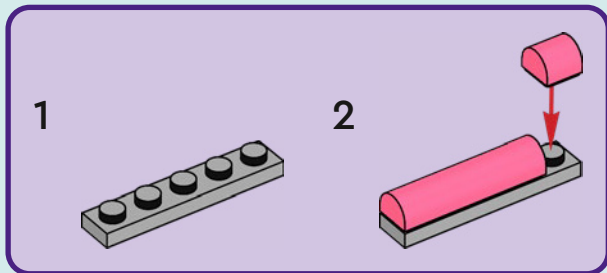



6x

75

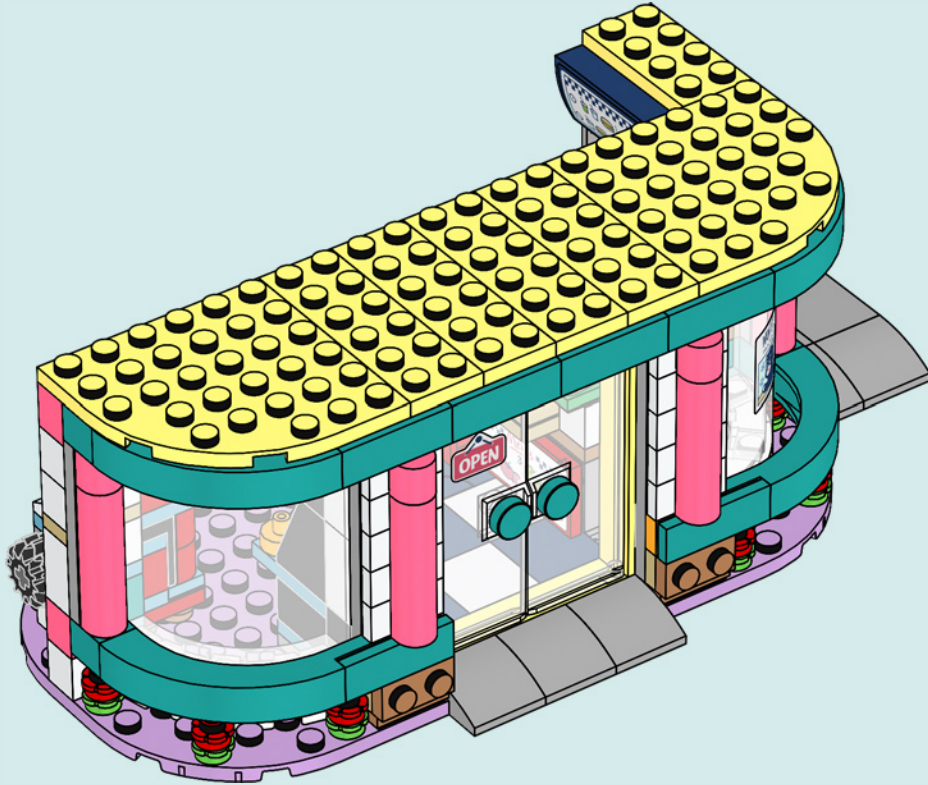



2x



2x

76

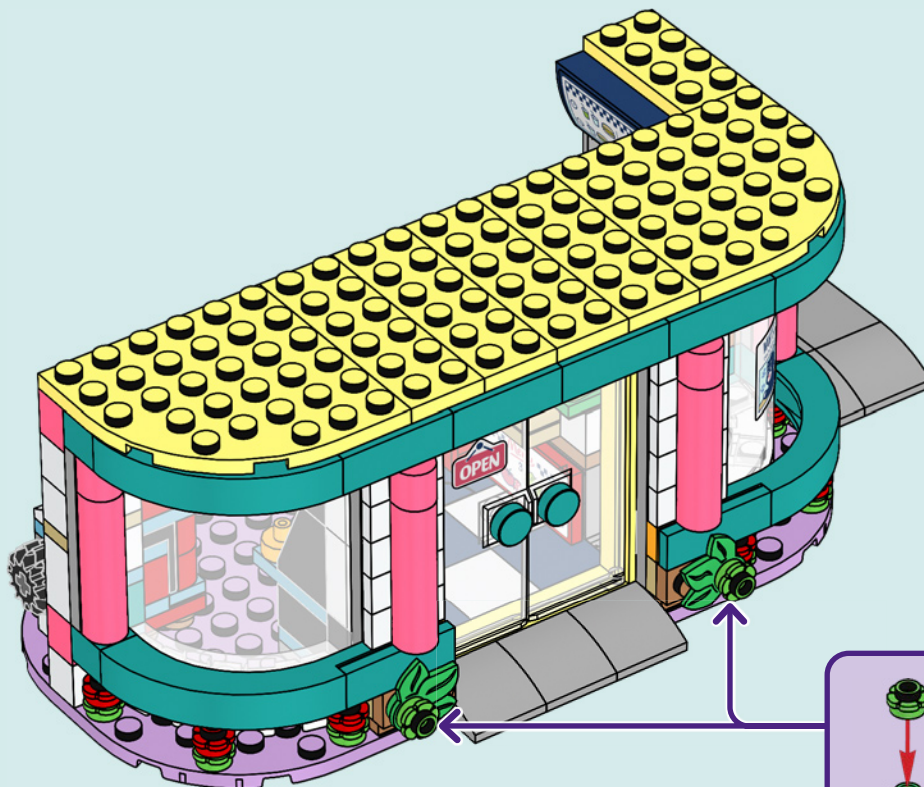

2x



2x

77

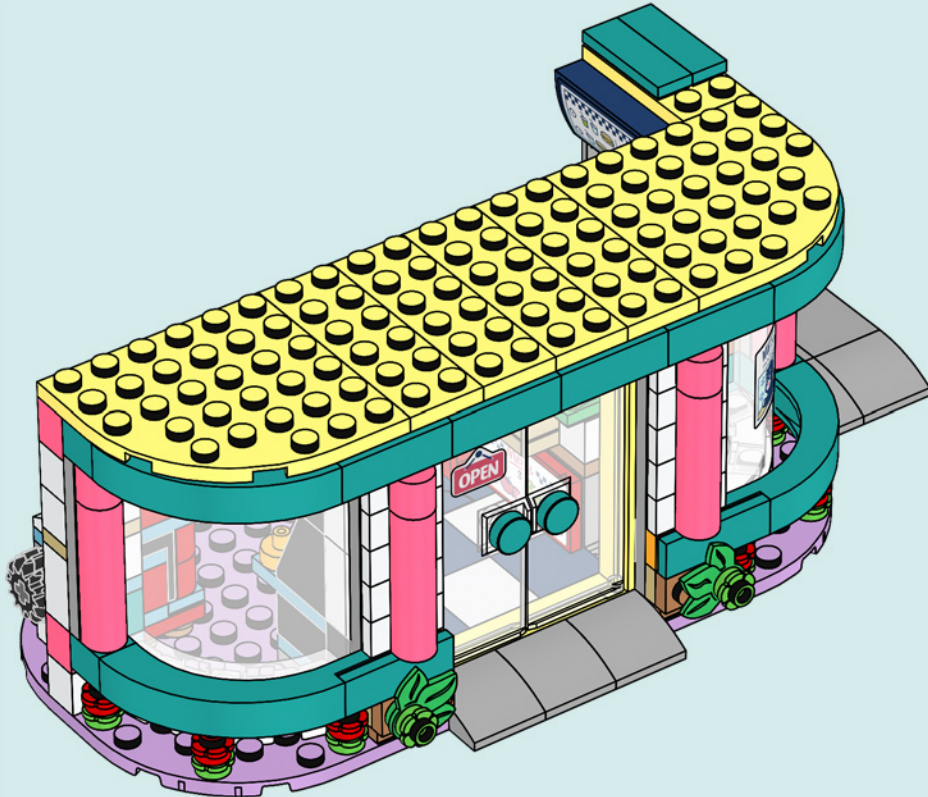



1x

78

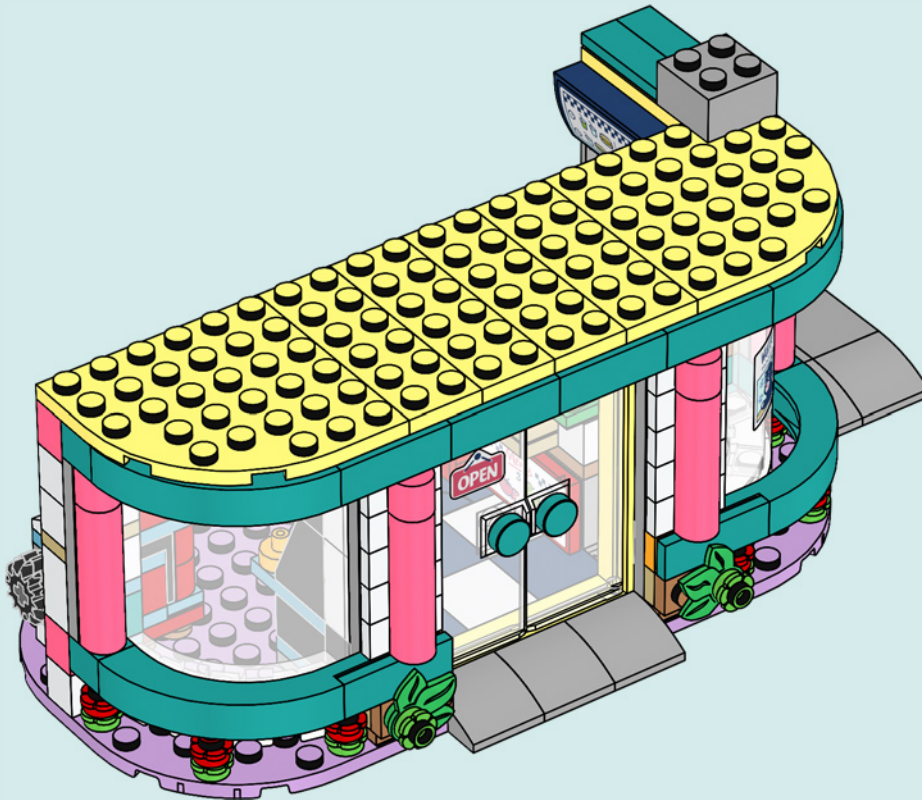



1x

79

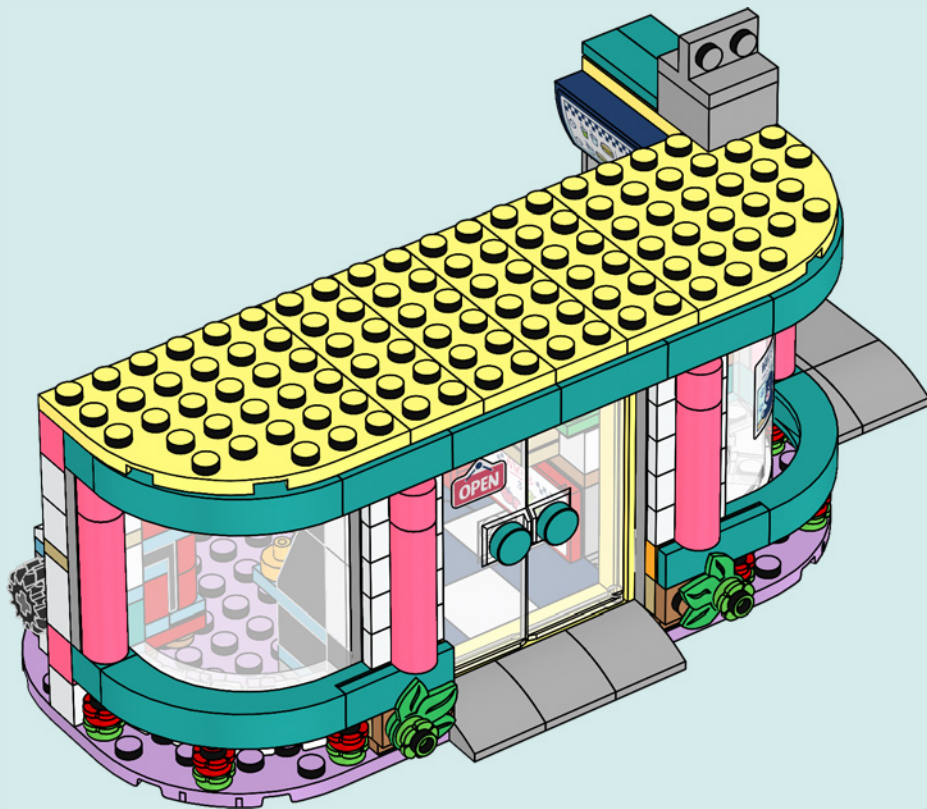

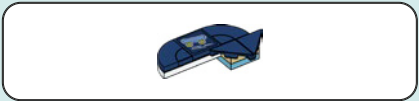

80



81

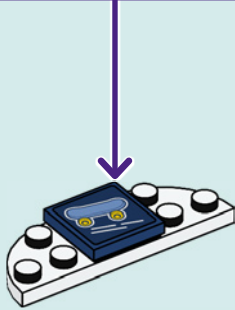
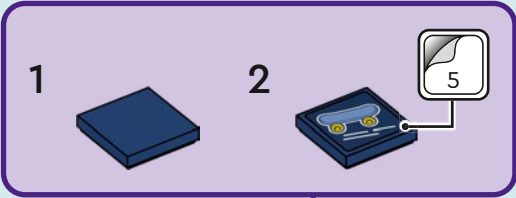



82

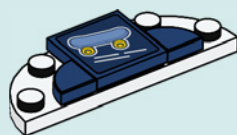

83

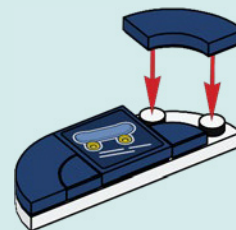

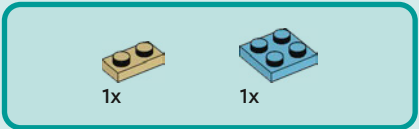

84

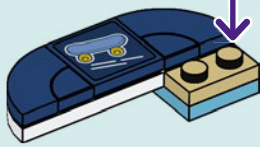
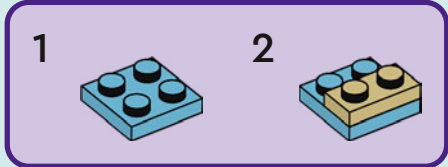

85

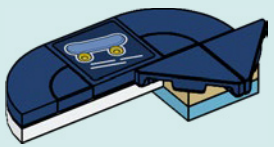

86

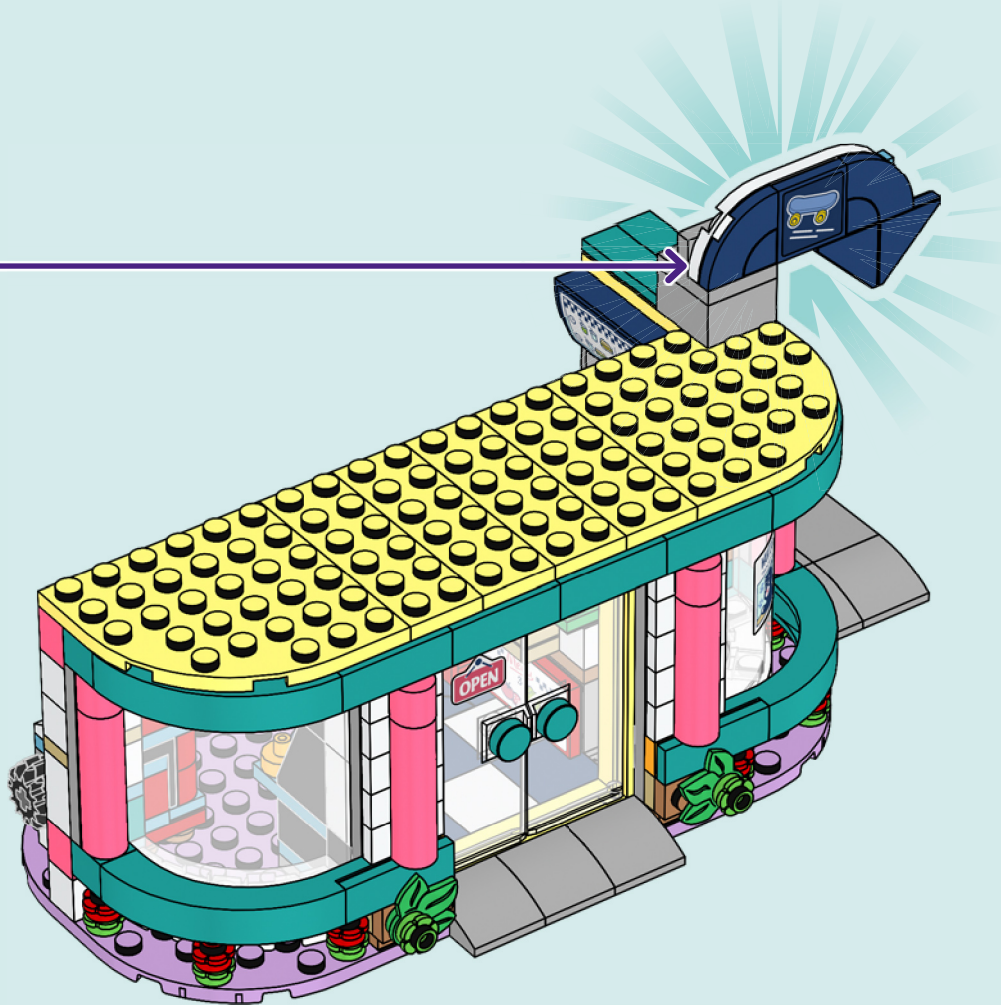





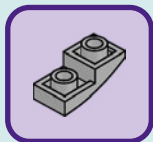

1x

87



			
2x	2x	1x	1x

88

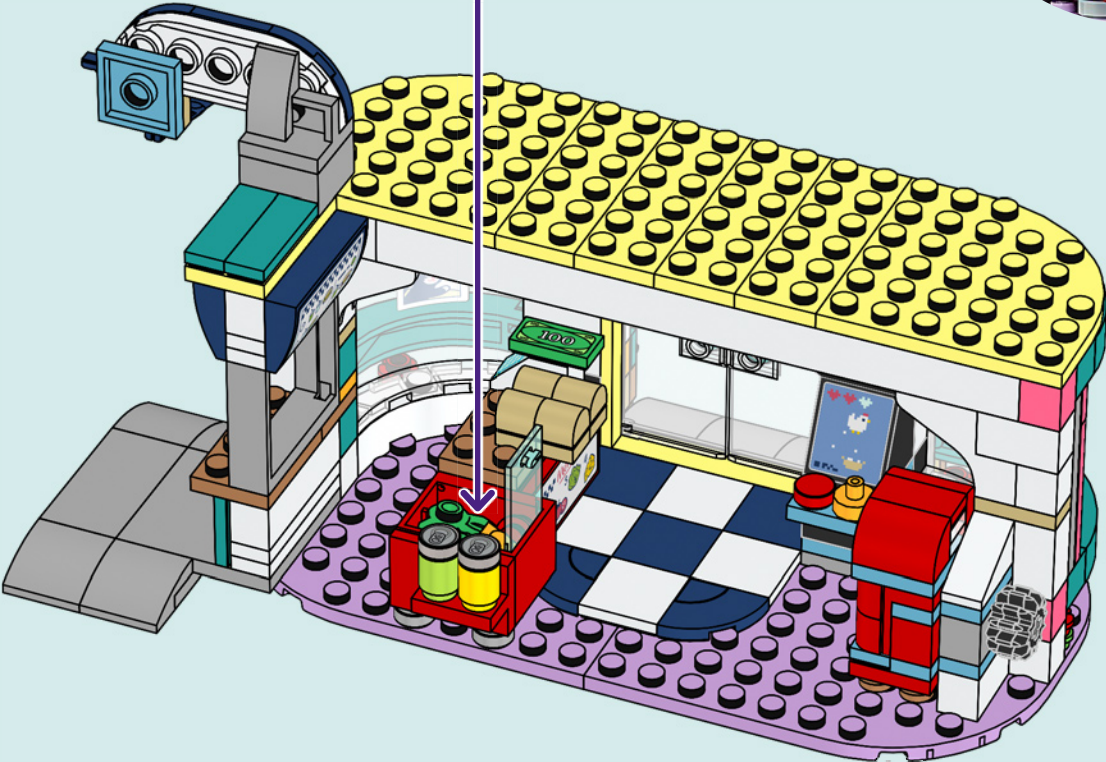
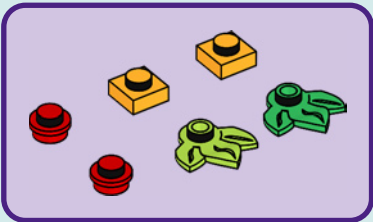

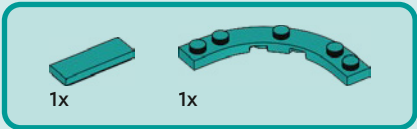

89

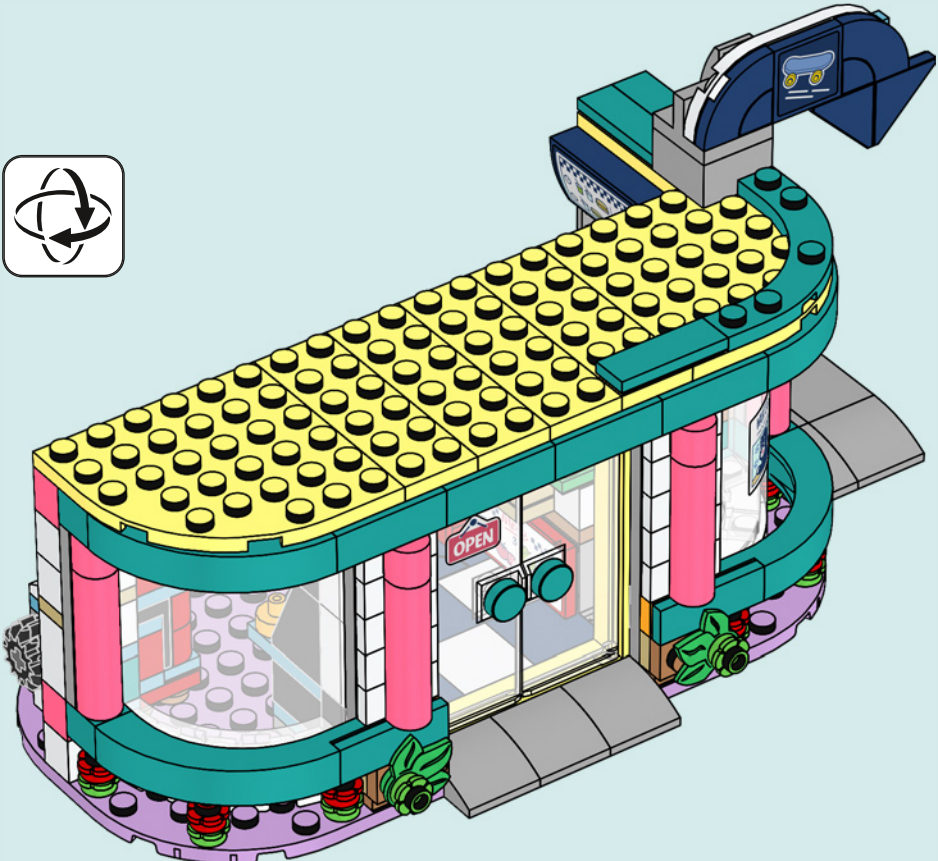



1x

90

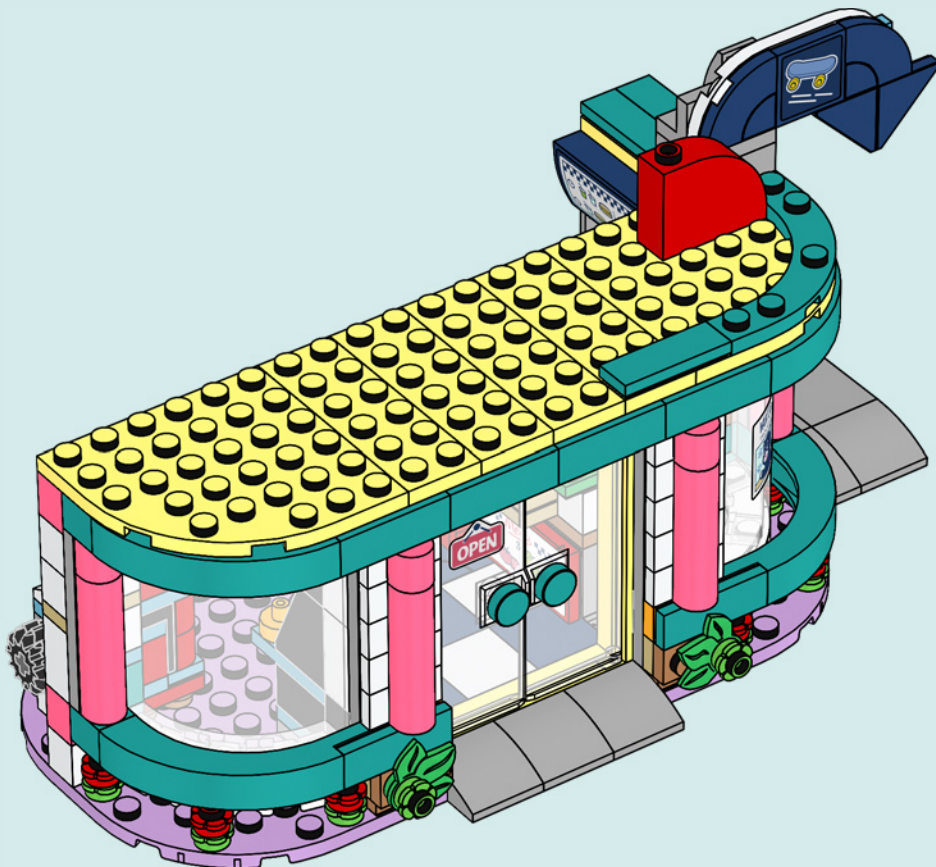

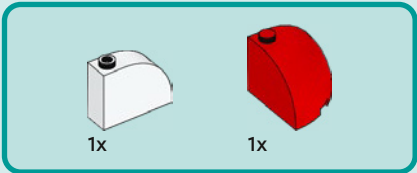

91

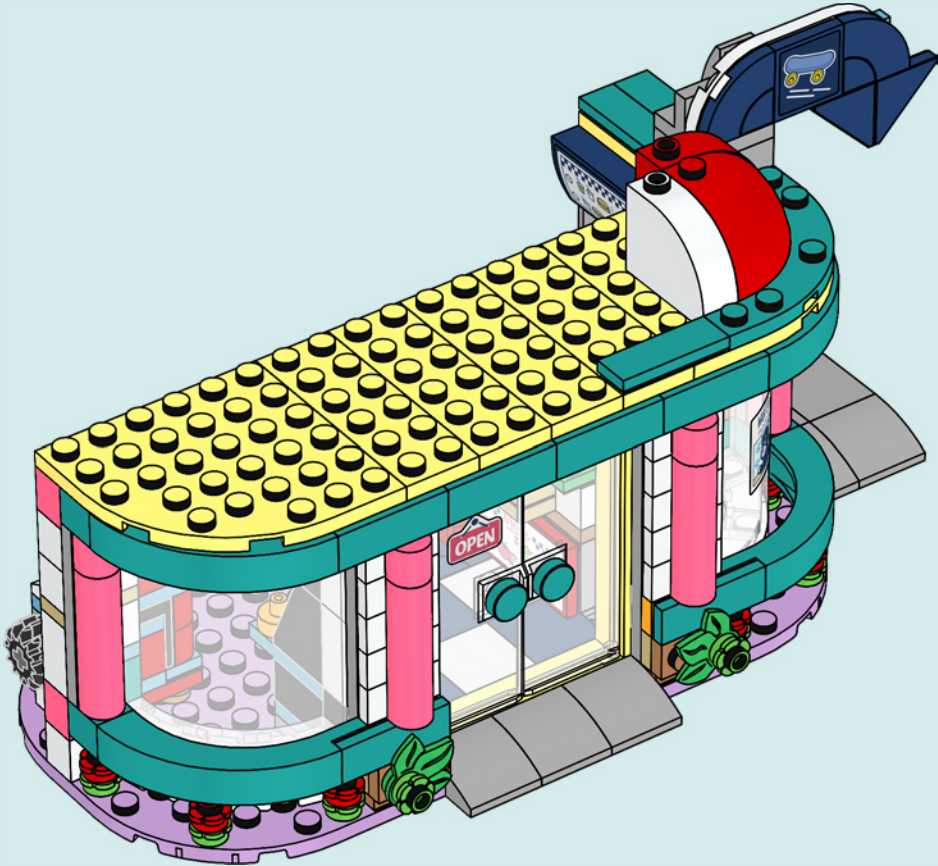

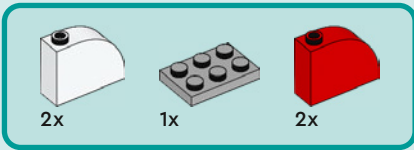

92

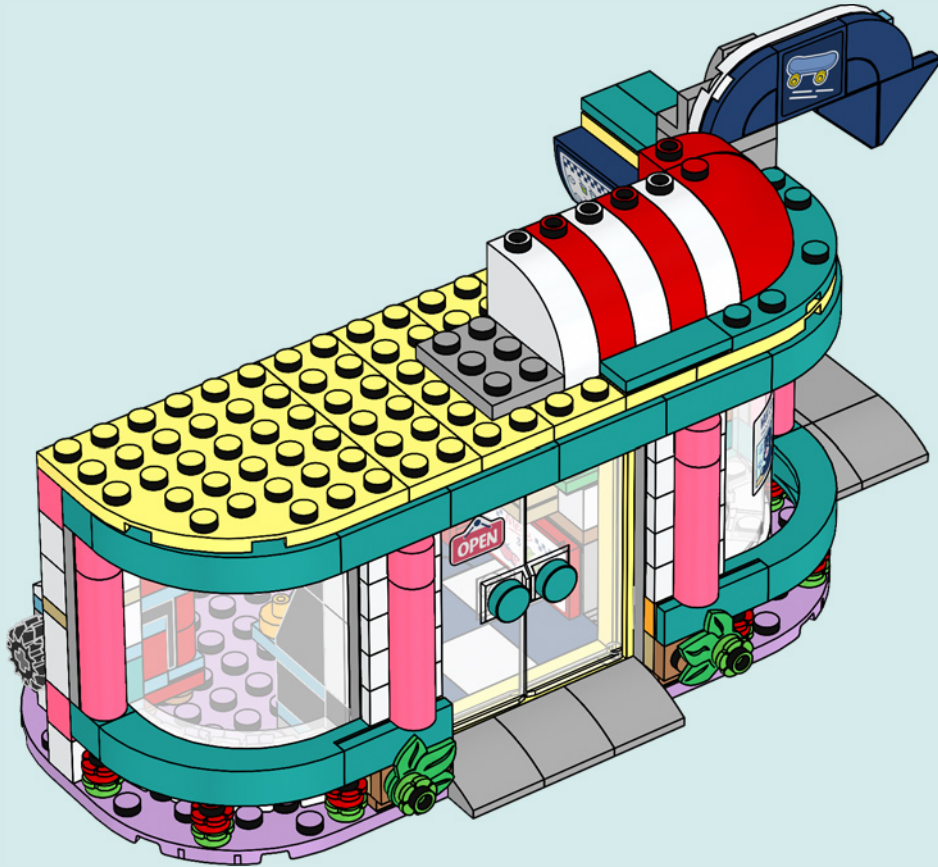



2x

93

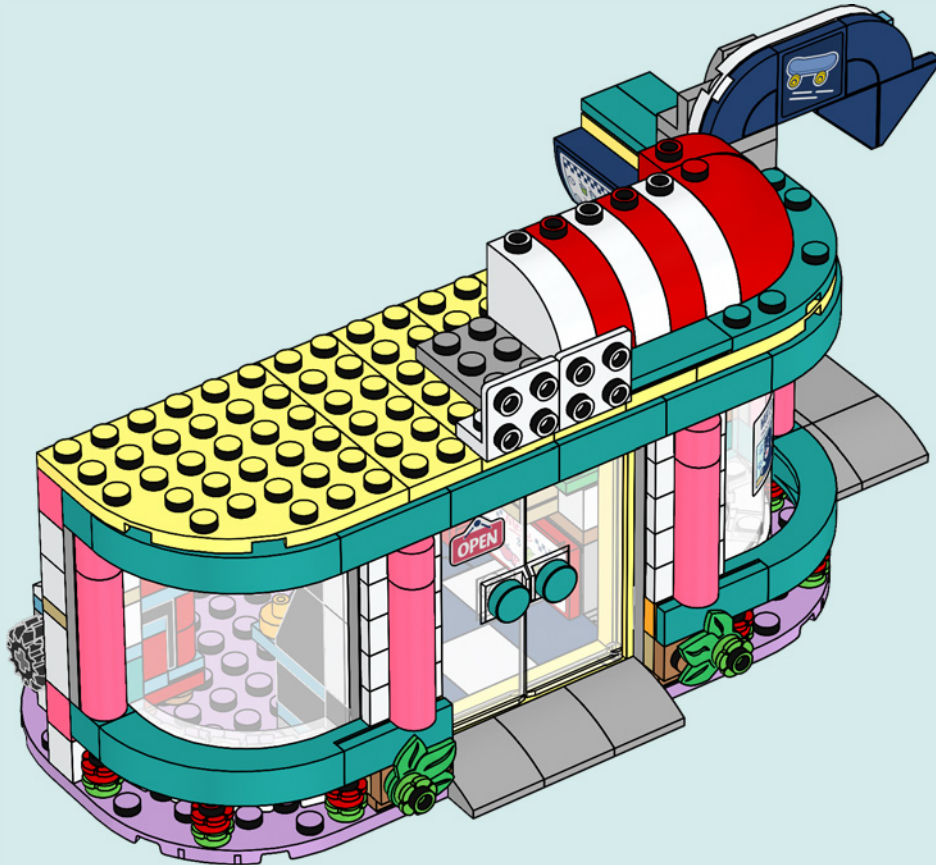

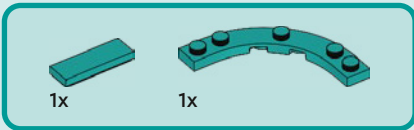

94

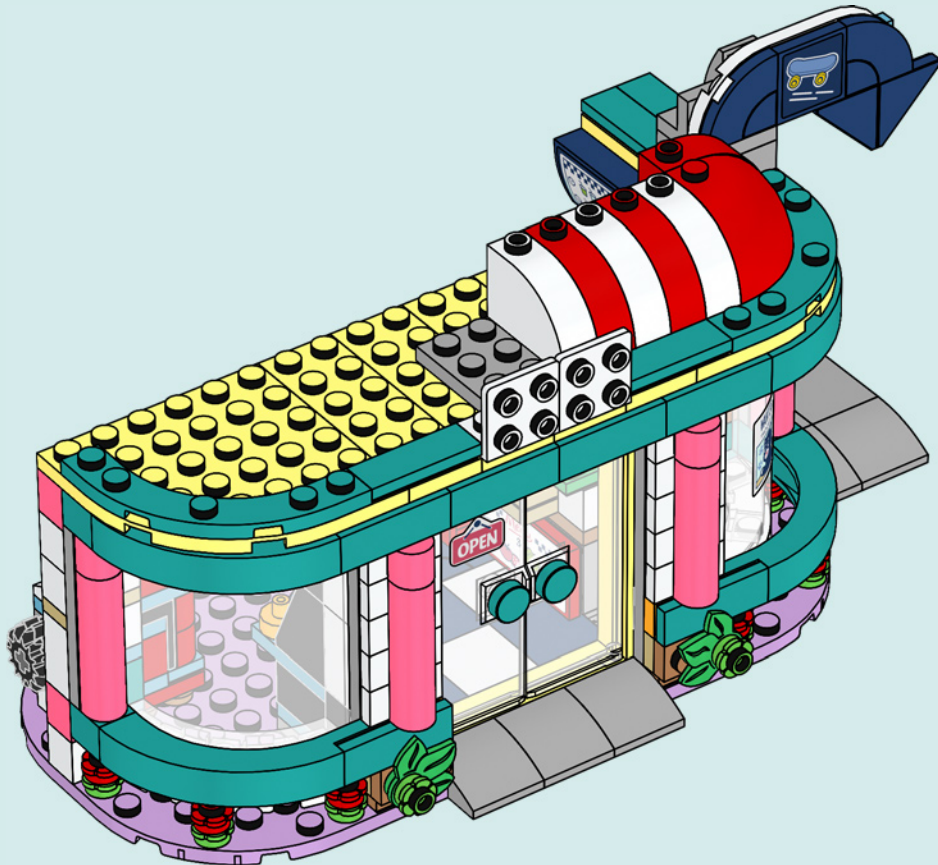

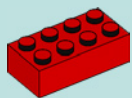

1x

95

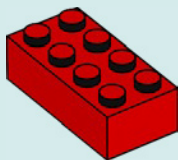

2x

96

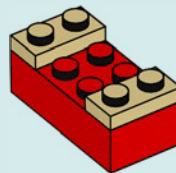



1x

97

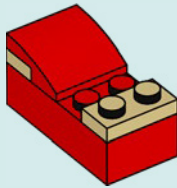

1x

98

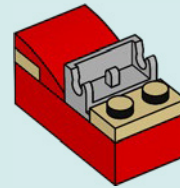

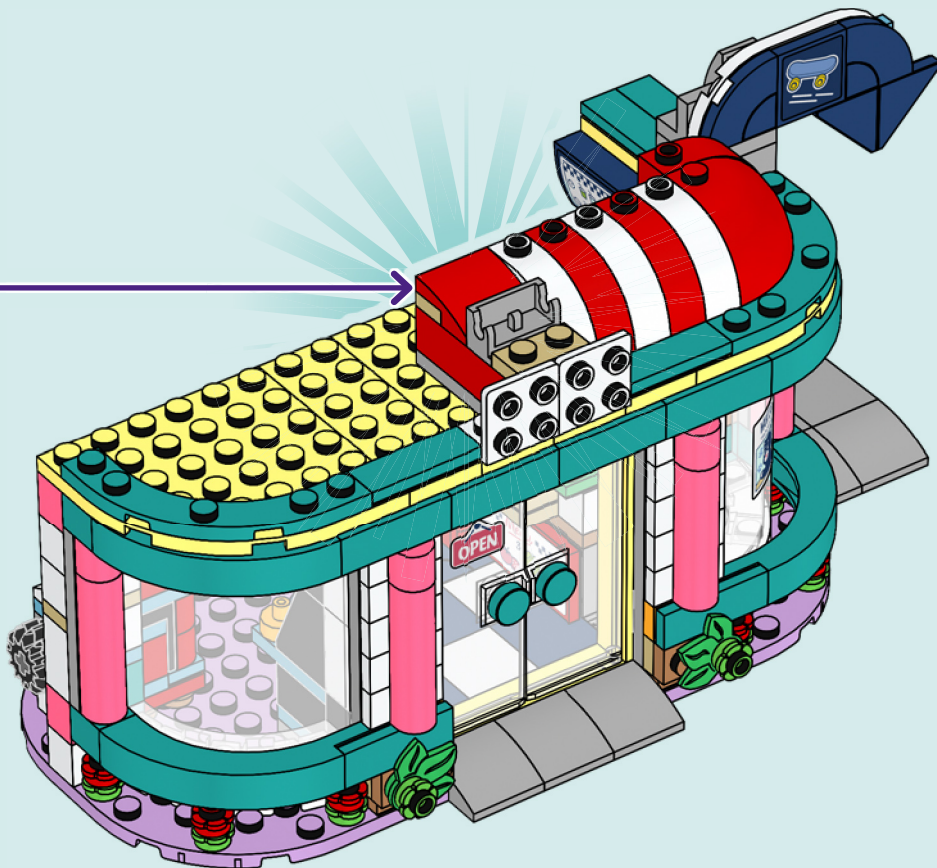



3x



2x

100

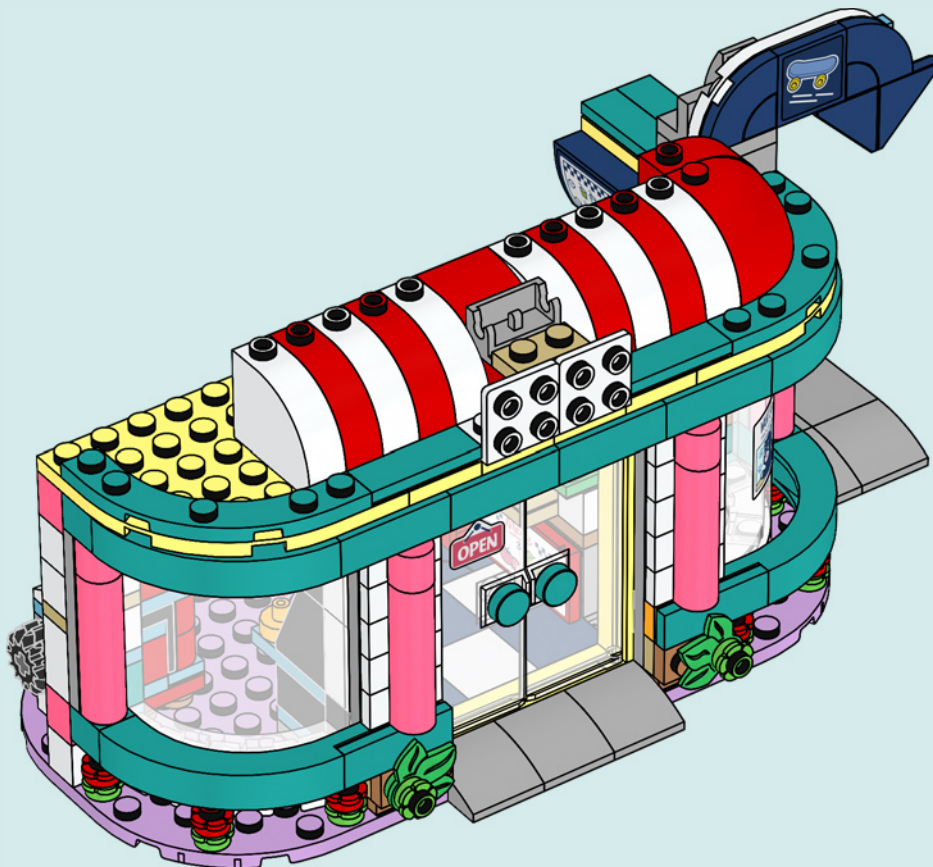

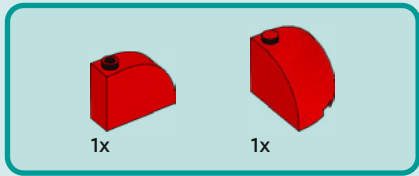

101

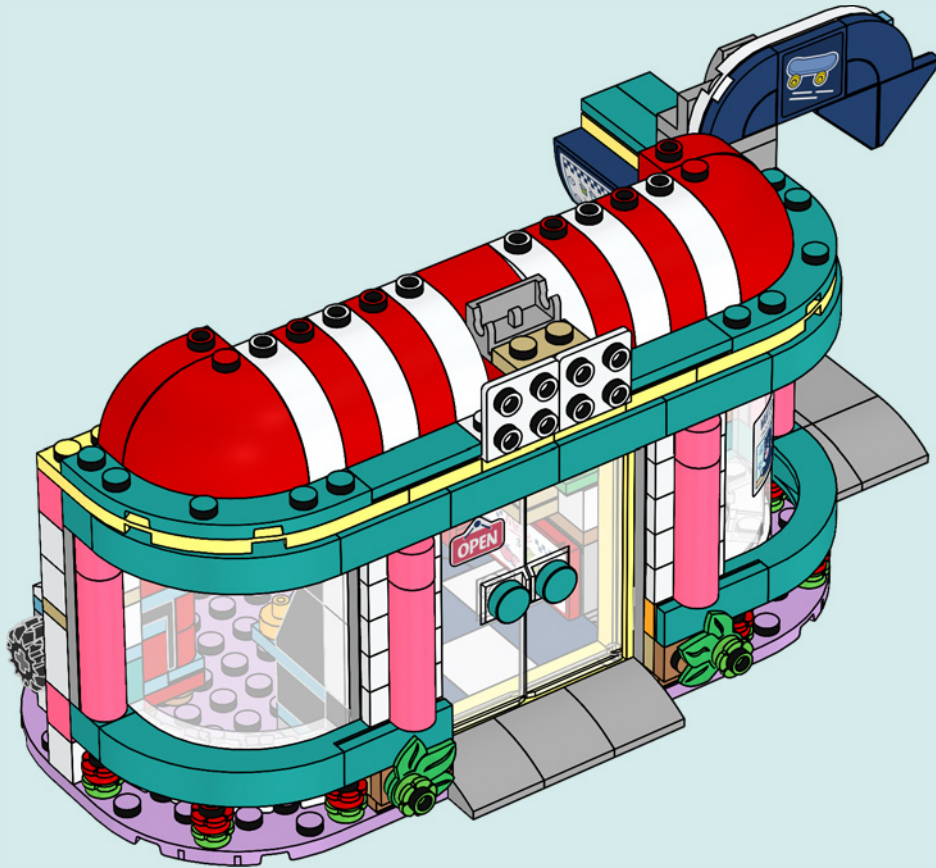

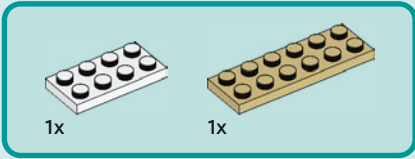
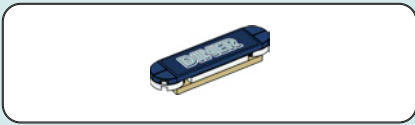

102

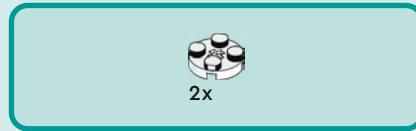
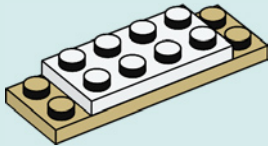

103

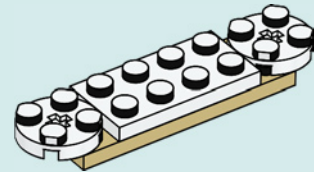

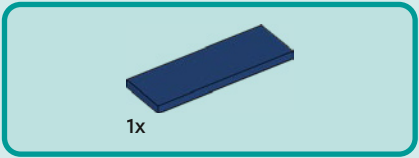

104

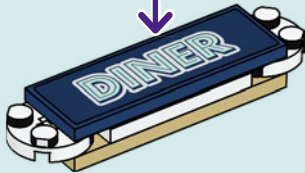
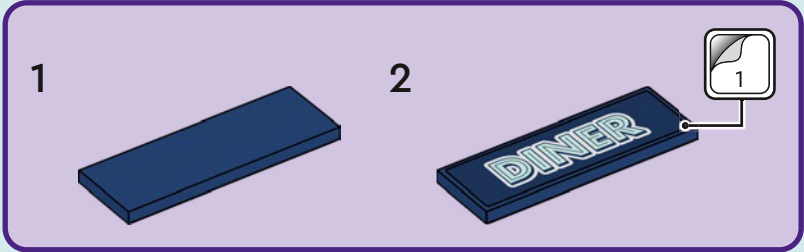



4x

105

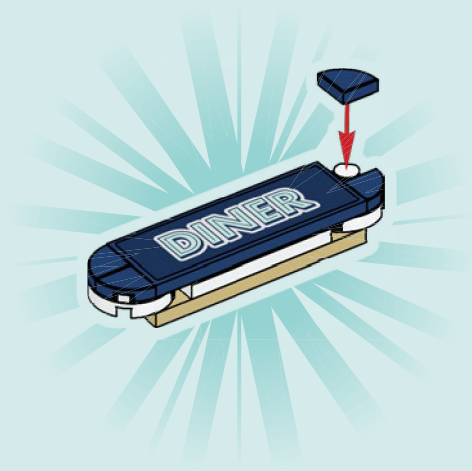

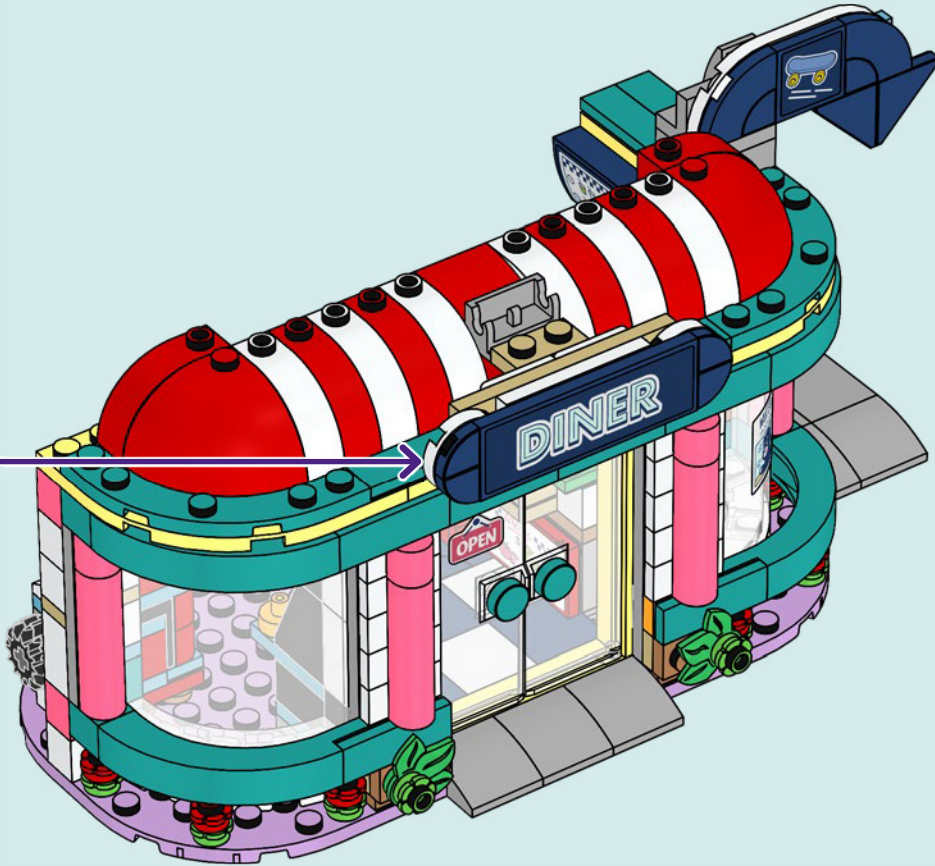



1x

107





1x



1x

108

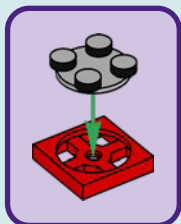

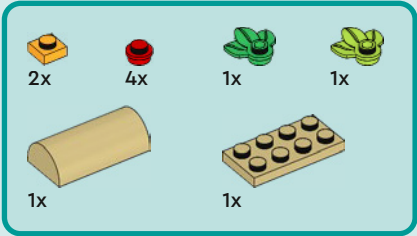

109

1

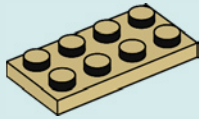

2



3

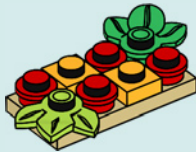

4

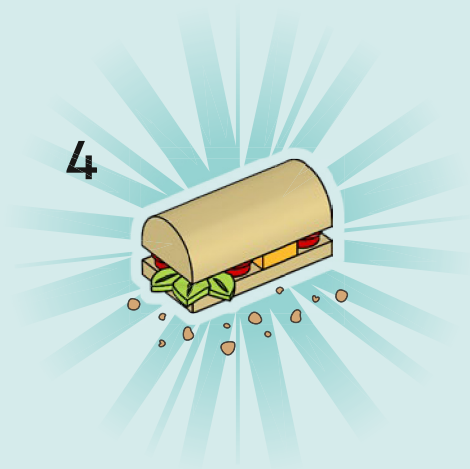







Friends



41731



41728



41743



Friends



AUTUMN

ALIYA

PAISLEY

ZAC

LEO

LIANN

OLLY

NOVA



 4x 6286329	 1x 4569056	 1x 306224	 4x 6229130	 2x 6311437	 1x 4504369	 1x 4612342
 11x 4113917	 2x 6252037	 1x 654124	 1x 4567908	 7x 6213776	 3x 300501	 2x 4568956
 1x 6375672	 1x 6117974	 1x 6416645	 1x 4295260	 2x 6421682	 2x 6218841	 6x 4141668
 1x 4113233	 1x 6393287	 1x 6380236	 1x 6171069	 10x 6213787	 1x 6425550	 1x 428601
 1x 4114309	 1x 6105976	 1x 6283610	 8x 6206150	 4x 6249417	 2x 403201	 4x 371001
 1x 6306069	 1x 368021	 1x 4177431	 2x 6240204	 1x 6223065	 6x 4113261	 3x 4143254
 1x 4124067	 2x 6334053	 1x 6409763	 1x 6236111	 4x 6390729	 7x 300401	 1x 6315024
 1x 4113993	 6x 6289870	 1x 6406097	 2x 6424464	 2x 6377247	 10x 6051511	 1x 302001
 8x 614121	 1x 302121	 3x 6138173	 1x 300326	 1x 4212454	 1x 6329697	 1x 6147792
 6x 6206148	 1x 4619543	 1x 4273703	 2x 6424464	 3x 6286831	 2x 6097637	 1x 346001
 1x 6284574	 1x 300121	 1x 6425507	 1x 6253216	 1x 6064097	 5x 306801	 1x 246501
 2x 300521	 1x 4560179				 1x 235701	
 4x 6278441						
 2x 306921						

8x
6199890



1x
6422987



2x
6214808



4x
4205004



4x
6199898



2x
6097430



1x
6326191



1x
6223719



8x
6073040



1x
6423146



2x
6284071



1x
6250597



1x
4211476



2x
4211415

1x
4540203



1x
4211440



1x
4211469



2x
6123809



1x
4211350



1x
6144138



5x
6258820



1x
4211387



1x
6212077



7x
6102357



1x
4211396



1x
6146299



1x
4211395



1x
4560183



2x
6372029

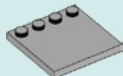

1x
4211837



1x
4211404



2x
4211406



2x
6106283



4x
6126083



1x
6015356



1x
6296524

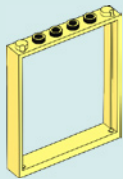

1x
6376998



4x
6175294



2x
6385626



1x
6416641



1x
6426039



1x
6409768



4x
6167641



2x
6218360



2x
6021997



1x
6177535



1x
6334099



1x
6093494



2x
6322904



1x
6329604



2x
4625032



1x
6060857



4x
6119107



1x
6097492



2x
4619513



1x
6213681



1x
6428177

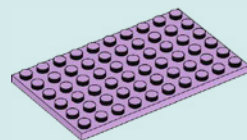

1x
6334051

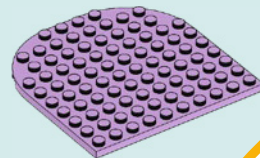

2x
6407529



4x
6261292



4x
6422223



4x
6258572



2x
6258095



10x
6422238



1x
6416663



1x
6422985



1x
6416546



1x
6423886

[LEGO.com/service](https://www.lego.com/service)



YOU COULD

WIN



Scan this QR code or go to
LEGO.COM/PRODUCTFEEDBACK and give
us your short feedback about this LEGO®
set for a chance to win a cool LEGO prize.

Terms and Conditions apply*

DE: Du könntest GEWINNEN. Es gelten die Teilnahmebedingungen* **FR: Tu pourrais GAGNER.** Des conditions s'appliquent* **IT: Potresti VINCERE tu.** Termini e condizioni sono applicabili* **ES: Puedes GANAR.** Aplican términos y condiciones* **PT: Poderá GANHAR.** Aplicam-se termos e condições* **JA: プレゼント付き! 利用規約が適用されます*** **ZH: 轻松获奖. 条款和条件适用*** **KO: 상품의 주인이 되어보세요. 소정의 약관이 적용됩니다*** **RU: Вы можете ВЫИГРАТЬ.** Действуют положения и условия* **PL: Szansa na WYGRANĄ.** Obowiązują warunki korzystania* **CS: Máte šanci VYHRÁT.** Platí všeobecné smluvní podmínky* **SK: Máte šancu VYHRAŤ.** Platia všeobecné zmluvné podmienky* **HU: TE IS NYERHETSZ.** Felhasználási feltételek érvényesek* **RO: Ai putea CÂȘTIGA.** Se aplică termeni și condiții* **BG: Можете да СПЕЧЕЛИТЕ.** Има определени правила и условия* **LV: Tu vari LAIMĒT.** Ir spēkā noteikumi un nosacījumi.* **ET: Sul on võimalus VÕITA.** Kehtivad tingimused* **LT: Jūs galite LAIMĖTI.** Taikomos sąlygos*
*LEGO.com/productfeedback-terms